

formül[®]



2022/1 FİYAT LİSTESİ



Formül; plastik sektöründeki ihtiyaçları karşılamak amaçlı üretim serüvenine, kurulduğu 1990'lı yılların başında bir **plastik kalıp atölyesi** olarak başlamıştır.

2000 yılında PP-R boru ve ek parçaları üretimine başlamıştır.

Yıllar içerisinde tecrübe kazanan firmamız çok gözlü kalıpları kendi bünyesinde yapan **tek firma** olmanın avantajıyla, PP-R boru ve ek parçalarında sektörde **en geniş ürün yelpazesine** sahip firma olmuştur.

Son yıllarda **Veliköy ve Çerkezköy** Organize Sanayi Bölgelerinde tamamen **Avrupa standartlarına uygun** modern fabrika binaları kurmuş ve makinelerini yenilemiştir. Montaj, ambalajlama, paketlenme ve kolileme çalışmaları otomatik makinelerde gerçekleştirilmektedir.

Formül; vanalar ve tüm metalli ek parçaların **metal aksamlarını** Çerkezköy'de bulunan tam otomatik makinalarla üretim yapan kendi tesisinden karşılamaktadır. **Kendi metal ihtiyaçlarını üreten** ender firmalardan biridir.

Son yıllarda sektörün ihtiyaç duyduğu iki farklı ürün grubu olan **PE-RT boru** ve **PVC atık su ürün grubunu** bünyesine katmıştır.

Kalorifer tesisatları ve yerden ısıtma sistemlerinde güvenle kullanılan **PE-RT Borular**, sıcaklık direnci yükseltilmiş ısıya dayanıklı polietilenden üretilen, **son derece esnek ve kolay döşenen borulardır.**

PVC atık su boruları, 50 mm - 200 mm çap aralığında üretilip, **Avrupa kökenli** makinelerce muflanmakta ve contalı olarak kullanıma sunulmaktadır.





Dünya'nın tercihi,
Türkiye'nin markası

formül[®]



Kalite Yönetimi



Formül; mükemmel ürün kalitesi, geniş ürün yelpazesi ve yüksek üretim kapasitesiyle üst yapı tesisat sektöründe iddialı firmalardan biridir. Ürün yelpazesinin geniş olması firmamızı, müşterilerinin yanı sıra diğer PPRC üreticilerinin de ilgi odağı haline getirmiştir. Model firma özelliği ile plastik sektöründe saygın bir yer edinmiştir.

Dünyanın her bölgesine satış yapmak ve rekabet üstünlüğü sağlamak için ihtiyaç duyduğu uluslararası tüm kalite belgelerine, faydalı model ve patent belgelerine, ISO 9001-2015 kalite belgesi, ISO 27001-2013 Bilgi Güvenliği Yönetim Sistemi ve AEO Yetkilendirilmiş Yükümlü Sertifikası belgelerine sahip olmuş ve ürünlerinin uluslararası marka tescillerini yaptırmıştır. Bu belgeler arasında çok tanınmış olan TSE, DVGW, AENOR, CSTB, GOST, AVIZ TEHNIC, UKR SEPRO, SKZ, TZW ve diğer ülkelerin kalite sertifikaları; bağımsız kuruluşlar tarafından periyodik olarak denetlenmektedir. Bu belgelerle, müşterilerine yüksek kaliteli ürün, projeye özel uygulamalar ve çözümlerle başarılı organizasyonlar yapmayı garanti etmektedir.

Uluslararası geçerliliği olan AEO (Yetkilendirilmiş Yükümlü Sertifikası) belgesine sahip olan sektörümüzde ilk firma Formül'dür. Bakanlık tarafından güvenilirliğini kanıtlamış firmalara verilen AEO sayesinde Formül, ithal ettiği eşyayı direkt olarak fabrikasına alabiliyor ve ihraç ettiği ürünleri de fabrikadan direkt olarak gümrük sınırına gönderebiliyor.

Zamanla 5 kıtada 80'in üzerinde ülkeye ihracat yapar duruma gelen Formül, 2014'ten beri ülkemizin "İlk 1000 ihracatçı firması" arasında yer almaktadır.

Kısa sürede Afrika, BDT ülkeleri, Uzak Doğu, Orta Doğu ve Güney Amerika'da popüler ve istenilen bir marka haline gelmiştir.

Kaliteli ve mükemmel ürün üretme hedefiyle beraber, en öne müşteri memnuniyetini almış; laboratuvar çalışmaları ve AR-GE bölümünün desteği ile hatasız ürün üretme ilkesini benimsemiştir.

Eğitilmiş, nitelikli ve tecrübeli ekibimiz sizlere hizmet etmekten mutlu olmaktadır...



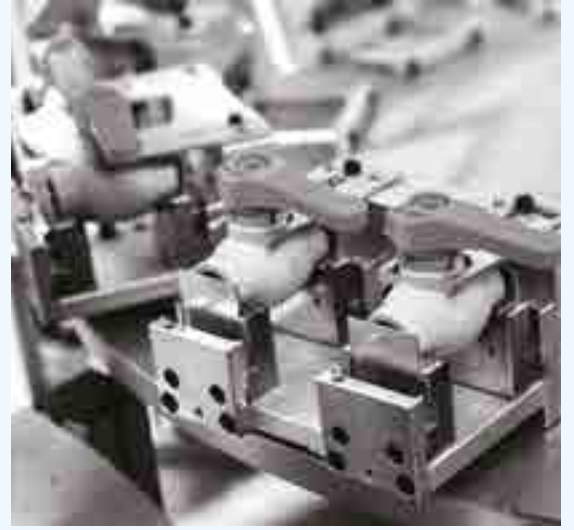
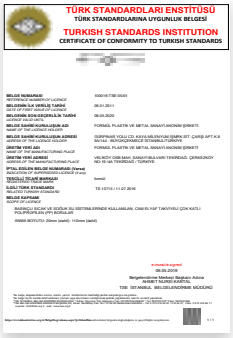

Notlar

- Fiyatlarımıza KDV dahil değildir.
- Fiyatlarımız fabrika teslim veya ambar teslim fiyatlarıdır.
- Firmamız haber vermeksizin fiyat değiştirme hakkına sahiptir.
- Lütfen siparişlerinizi faksla veya satis@formul.com.tr, satis-destek@formul.com.tr ve satis-operasyon@formul.com.tr adreslerine e-mail ile bildiriniz.
- Baskıdaki fiyat yazım hatalarından firmamız sorumlu değildir.





Hayatın
bir **FORMÜL**'ü var



formül[®]

**PVC BORU ve
EK PARÇALARI**

1

PVC ATIK SU BORUSU - TİP 1



PVC ATIK SU BORUSU - TİP 2



Kod	Ölçü	Miktar	Fiyat ₺
TP1-050015	50/150	100 Adet /Çuval	17,630
TP1-050025	50/250	80 Adet /Çuval	24,980
TP1-050050	50/500	40 Adet/Çuval	38,990
TP1-050100	50/1000	10 Adet/Bağ	65,190
TP1-050200	50/2000	10 Adet/Bağ	127,060
TP1-050300	50/3000	10 Adet/Bağ	189,220
TP1-050600	50/6000	1 Adet	367,550
TP1-075015	75/150	60 Adet /Çuval	30,470
TP1-075025	75/250	40 Adet /Çuval	44,070
TP1-075050	75/500	20 Adet/Çuval	62,740
TP1-075100	75/1000	5 Adet/Bağ	110,350
TP1-075200	75/2000	5 Adet/Bağ	213,830
TP1-075300	75/3000	5 Adet/Bağ	315,530
TP1-075600	75/6000	1 Adet	619,160
TP1-110015	110/150	30 Adet /Çuval	46,150
TP1-110025	110/250	20 Adet /Çuval	64,550
TP1-110050	110/500	10 Adet/Çuval	98,440
TP1-110100	110/1000	5 Adet/Bağ	167,530
TP1-110200	110/2000	5 Adet/Bağ	326,540
TP1-110300	110/3000	4 Adet/Bağ	468,170
TP1-110600	110/6000	1 Adet	928,210
TP1-125015	125/150	24 Adet /Çuval	60,640
TP1-125025	125/250	16 Adet /Çuval	85,370
TP1-125050	125/500	10 Adet /Bağ	126,030
TP1-125100	125/1000	5 Adet /Bağ	216,300
TP1-125200	125/2000	5 Adet /Bağ	417,720
TP1-125300	125/3000	3 Adet /Bağ	618,560
TP1-125600	125/6000	1 Adet	1.229,690
TP1-160015	160/150	15 Adet /Bağ	91,420
TP1-160025	160/250	12 Adet /Bağ	125,250
TP1-160050	160/500	6 Adet /Bağ	214,900
TP1-160100	160/1000	4 Adet /Bağ	364,090
TP1-160200	160/2000	3 Adet /Bağ	696,540
TP1-160300	160/3000	1 Adet /Bağ	1.024,470
TP1-160600	160/6000	1 Adet	1.992,570
TP1-200015	200/150	9 Adet /Bağ	151,260
TP1-200025	200/250	9 Adet /Bağ	202,700
TP1-200050	200/500	6 Adet /Bağ	339,880
TP1-200100	200/1000	3 Adet	596,980
TP1-200200	200/2000	1 Adet	1.140,390
TP1-200300	200/3000	1 Adet	1.667,060
TP1-200600	200/6000	1 Adet	3.230,060

Kod	Ölçü	Miktar	Fiyat ₺
TP2-050050	50/500	40 Adet/Çuval	25,700
TP2-050100	50/1000	10 Adet/Bağ	45,430
TP2-050200	50/2000	10 Adet/Bağ	88,020
TP2-050300	50/3000	10 Adet/Bağ	131,030
TP2-050600	50/6000	1 Adet	256,770
TP2-075050	75/500	20 Adet/Çuval	41,480
TP2-075100	75/1000	5 Adet/Bağ	75,040
TP2-075200	75/2000	5 Adet/Bağ	144,920
TP2-075300	75/3000	5 Adet/Bağ	214,400
TP2-075600	75/6000	1 Adet	418,660
TP2-110050	110/500	10 Adet/Çuval	68,520
TP2-110100	110/1000	5 Adet/Bağ	119,300
TP2-110200	110/2000	5 Adet/Bağ	231,260
TP2-110300	110/3000	5 Adet/Bağ	341,810
TP2-110600	110/6000	1 Adet	658,580
TP2-125050	125/500	10 Adet /Bağ	94,160
TP2-125100	125/1000	5 Adet /Bağ	168,790
TP2-125200	125/2000	5 Adet /Bağ	322,080
TP2-125300	125/3000	3 Adet /Bağ	475,190
TP2-125600	125/6000	1 Adet	928,400
TP2-160050	160/500	6 Adet /Bağ	168,560
TP2-160100	160/1000	4 Adet /Bağ	298,150
TP2-160200	160/2000	3 Adet /Bağ	571,050
TP2-160300	160/3000	3 Adet /Bağ	839,550
TP2-160600	160/6000	1 Adet	1.675,080
TP2-200050	200/500	6 Adet /Bağ	274,570
TP2-200100	200/1000	3 Adet	478,250
TP2-200200	200/2000	1 Adet	898,500
TP2-200300	200/3000	1 Adet	1.300,910
TP2-200600	200/6000	1 Adet	2.557,720

Kod	Ölçü	Miktar	Fiyat ₺
DRS-050045	50	200 Adet/Çuval	13,050
DRS-075045	75	100 Adet/Çuval	22,980
DRS-110045	110	35 Adet/Çuval	45,470
DRS-125045	125	25 Adet/Çuval	66,580
DRS-160045	160	15 Adet/Çuval	128,680
DRS-200045	200	6 Adet/Çuval	325,140



Kod	Ölçü	Miktar	Fiyat ₺
DRS-050087	50	150 Adet/Çuval	15,430
DRS-075087	75	75 Adet/Çuval	29,880
DRS-110087	110	30 Adet/Çuval	57,300
DRS-125087	125	20 Adet/Çuval	83,790
DRS-160087	160	12 Adet/Çuval	169,570
DRS-200087	200	5 Adet/Çuval	441,260



Kod	Ölçü	Miktar	Fiyat ₺
TEC-050050	50x50	125 Adet/Çuval	28,170
TEC-075050	75x50	70 Adet/Çuval	42,390
TEC-075075	75x75	50 Adet/Çuval	53,700
TEC-110050	110x50	30 Adet/Çuval	62,700
TEC-110075	110x75	25 Adet/Çuval	88,070
TEC-110110	110x110	20 Adet/Çuval	95,780
TEC-125125	125x125	10 Adet/Bağ	169,500
TEC-160110	160x110	10 Adet/Bağ	251,690
TEC-160160	160x160	8 Adet/Bağ	363,910



Kod	Ölçü	Miktar	Fiyat ₺
TKC-050050	50x50	100 Adet/Çuval	26,440
TKC-075050	75x50	50 Adet/Çuval	39,750
TKC-075075	75x75	40 Adet/Çuval	59,880
TKC-110050	110x50	25 Adet/Çuval	63,290
TKC-110075	110x75	20 Adet/Çuval	89,120
TKC-110110	110x110	15 Adet/Çuval	110,470
TKC-125110	125x110	10 Adet/Bağ	161,850
TKC-125125	125x125	10 Adet/Bağ	196,110
TKC-160110	160x110	5 Adet/Bağ	277,410
TKC-160160	160x160	4 Adet/Bağ	425,660



ÇİFT ÇATAL 45°



Kod	Ölçü	Miktar	Fiyat ₺
YCC-050050	50x50	60 Adet/Çuval	49,400
YCC-075050	75x50	40 Adet/Çuval	70,310
YCC-075075	75x75	25 Adet/Çuval	111,950
YCC-110050	110x50	25 Adet/Çuval	107,490
YCC-110075	110x75	15 Adet/Çuval	164,960
YCC-110110	110x110	10 Adet/Bağ	170,640

İSTAVROZ TE 87°



Kod	Ölçü	Miktar	Fiyat ₺
TCC-050050	50x50	75 Adet/Çuval	42,700
TCC-110110	110x110	10 Adet/Bağ	147,080

KAYAR MANŞON



Kod	Ölçü	Miktar	Fiyat ₺
KMN-050000	50	200 Adet/Çuval	18,930
KMN-075000	75	100 Adet/Çuval	30,210
KMN-110000	110	40 Adet/Çuval	53,910
KMN-125000	125	25 Adet/Çuval	93,020
KMN-160000	160	12 Adet/Çuval	168,660

REDÜKSİYON



Kod	Ölçü	Miktar	Fiyat ₺
RDK-075050	75x50	150 Adet/Çuval	20,600
RDK-110050	110x50	70 Adet/Çuval	33,130
RDK-110075	110x75	50 Adet/Çuval	34,790
RDK-125075	125x75	50 Adet/Çuval	64,610
RDK-125110	125x110	30 Adet/Çuval	65,720
RDK-160110	160x110	25 Adet/Çuval	119,940

TEMİZLEME TE

Kod	Ölçü	Miktar	Fiyat ₺
TMT-050000	50	100 Adet/Çuval	54,530
TMT-075000	75	50 Adet/Çuval	62,510
TMT-110000	110	15 Adet/Çuval	120,880
TMT-125000	125	10 Adet/Bağ	219,180

**MUF TAPASI**

Kod	Ölçü	Miktar	Fiyat ₺
KPM-050000	50	750 Adet/Çuval	9,920
KPM-075000	75	400 Adet/Çuval	17,980
KPM-110000	110	150 Adet/Çuval	24,530
KPM-125000	125	125 Adet/Çuval	40,740
KPM-160000	160	75 Adet/Çuval	83,110
KPM-200000	200	50 Adet/Çuval	178,440

**S SİFON**

Kod	Ölçü	Miktar	Fiyat ₺
SFN-110087	110x87°	10 Adet/Çuval	155,100
SFN-110045	110x45°	10 Adet/Çuval	144,440

**KADA**

Kod	Ölçü	Miktar	Fiyat ₺
EKK-110000	110	150 Adet / Çuval	55,000



ADAPTÖR CONTA



Kod	Ölçü	Miktar	Fiyat ₺
ADC-050000	50	750 Adet / Çuval	5,400

ATIK SU KELEPÇESİ



Kod	Ölçü	Miktar	Fiyat ₺
ATK-050000	50 mm	250 Adet/Koli	5,550
ATK-075000	75 mm	100 Adet/Koli	8,640
ATK-110000	110 mm	130 Adet/Koli	14,450
ATK-125000	125 mm	100 Adet/Koli	23,050
ATK-160000	160 mm	75 Adet/Koli	35,390
ATK-200000	200 mm	35 Adet/Koli	75,000

KİLİTLİ ÇEKVALF



Kod	Ölçü	Miktar	Fiyat ₺
KLC-110000	110	12	520,000
KLC-125000	125	12	650,000
KLC-160000	160	8	950,000
KLC-200000	200	4	1.850,000



yerli üretim

stoktan hızlı teslim

zengin ürün yelpazesi



Çocuklarımıza
YAŞANABİLİR ŞEHİRLER
Borçluyuz.



formül[®]

**PP-R BORU ve
EK PARÇALARI**

2

PP-R BORU PN 10

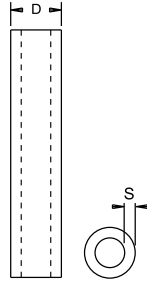
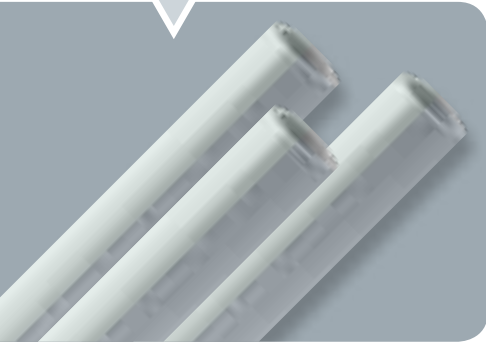

Kod	Ölçü (ø)	S	D	Miktar	Fiyat ₺
DUZ-200010	20	1.9	20.3	140/4.00	19,910
DUZ-250010	25	2.3	25.3	100/4.00	28,770
DUZ-320010	32	2.9	32.3	60/4.00	49,190
DUZ-400010	40	3.7	40.4	40/4.00	83,930
DUZ-500010	50	4.6	50.5	24/4.00	123,050
DUZ-630010	63	5.8	63.6	20/4.00	206,910
DUZ-750010	75	6.8	75.7	12/4.00	263,780
DUZ-900010	90	8.2	90.9	8/4.00	456,000
DUZ-110010	110	10	111	4/4.00	633,330
DUZ-125010	125	11.4	126.2	4/4.00	1.069,960

PP-R BORU PN 16

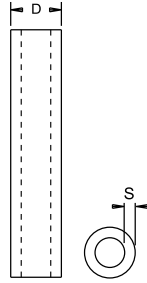
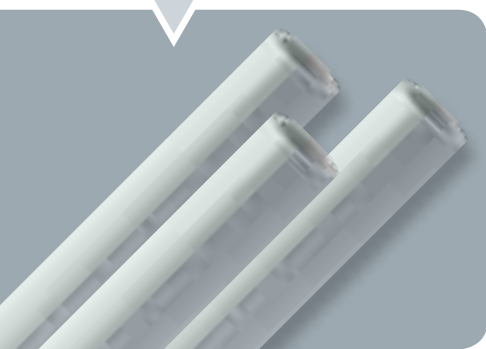

Kod	Ölçü (ø)	S	D	Miktar	Fiyat ₺
DUZ-200016	20	2.8	20.3	140/4.00	22,170
DUZ-250016	25	3.5	25.3	100/4.00	34,240
DUZ-320016	32	4.4	32.3	60/4.00	63,900
DUZ-400016	40	5.5	40.4	40/4.00	99,100
DUZ-500016	50	6.9	50.5	24/4.00	157,960
DUZ-630016	63	8.6	63.6	20/4.00	249,710
DUZ-750016	75	10.3	75.7	12/4.00	356,820
DUZ-900016	90	12.3	90.9	8/4.00	570,660
DUZ-110016	110	15.1	111	4/4.00	851,590
DUZ-125016	125	17.1	126.2	4/4.00	1.152,260

PP-R BORU PN 20

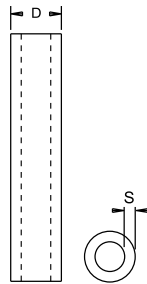
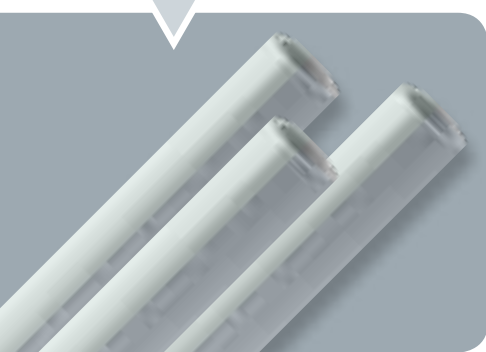

Kod	Ölçü (ø)	S	D	Miktar	Fiyat ₺
DUZ-200020	20	3.4	20.3	140/4.00	25,950
DUZ-250020	25	4.2	25.3	100/4.00	42,800
DUZ-320020	32	5.4	32.3	60/4.00	82,460
DUZ-400020	40	6.7	40.4	40/4.00	116,410
DUZ-500020	50	8.3	50.5	24/4.00	185,900
DUZ-630020	63	10.5	63.6	20/4.00	298,180
DUZ-750020	75	12.5	75.7	12/4.00	450,390
DUZ-900020	90	15.0	90.9	8/4.00	725,490
DUZ-110020	110	18.3	111	4/4.00	1.079,910
DUZ-125020	125	20.8	126.2	4/4.00	1.381,060

PP-R FOROXİ BORU PN 25

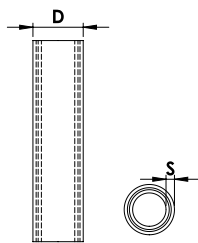
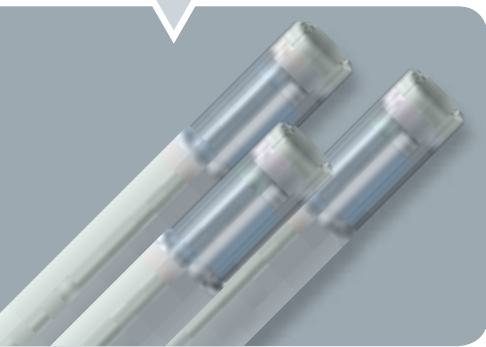

Kod	Ölçü (ø)	S	D	Miktar	Fiyat ₺
OFL-200025	20	3.4	20.3	140/4.00	48,630
OFL-250025	25	4.2	25.3	100/4.00	69,300
OFL-320025	32	5.4	32.3	60/4.00	115,500
OFL-400025	40	6.7	40.4	40/4.00	161,220
OFL-500025	50	8.3	50.5	24/4.00	243,550
OFL-630025	63	10.5	63.6	20/4.00	376,910
OFL-750025	75	12.5	75.7	12/4.00	645,910
OFL-900025	90	15.0	90.9	8/4.00	930,110

Kod	Ölçü (ø)	S	D	Miktar	Fiyat ₺
DGF-200020	20	2.8	20.3	140/4.00	27,850
DGF-250020	25	3.5	25.3	100/4.00	42,700
DGF-320020	32	4.4	32.3	60/4.00	68,120
DGF-400020	40	5.5	40.4	40/4.00	106,080
DGF-500020	50	6.9	50.5	24/4.00	173,320
DGF-630020	63	8.6	63.6	20/4.00	269,990
DGF-750020	75	10.3	75.7	12/4.00	387,250
DGF-900020	90	12.3	90.9	8/4.00	579,040
DGF-110020	110	15.1	111	4/4.00	884,170
DGF-125020	125	17.1	126.2	4/4.00	1.185,870

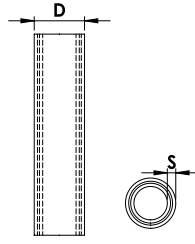

PP-R KOMPOZİT BORU PN 20

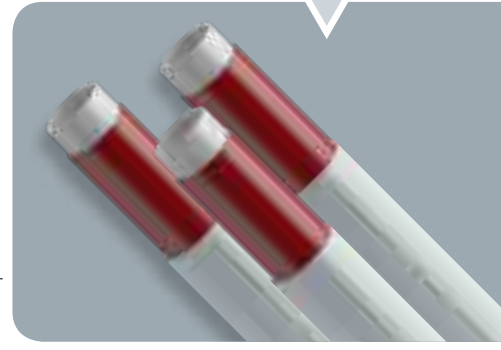

Kod	Ölçü (ø)	S	D	Miktar	Fiyat ₺
DGF-200025	20	3.4	20.3	140/4.00	33,160
DGF-250025	25	4.2	25.3	100/4.00	48,650
DGF-320025	32	5.4	32.3	60/4.00	86,310
DGF-400025	40	6.7	40.4	40/4.00	134,150
DGF-500025	50	8.3	50.5	24/4.00	212,530
DGF-630025	63	10.5	63.6	20/4.00	333,160
DGF-750025	75	12.5	75.7	12/4.00	472,960
DGF-900025	90	15.0	90.9	8/4.00	681,300
DGF-110025	110	18.3	111	4/4.00	1.036,450
DGF-125025	125	20.8	126.2	4/4.00	1.393,930

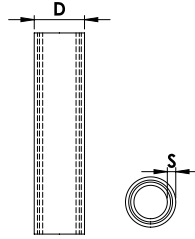

PP-R KOMPOZİT BORU PN 25

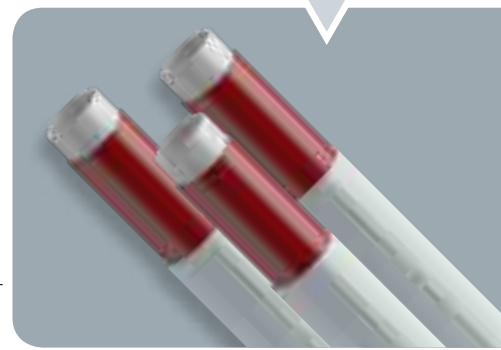

Kod	Ölçü (ø)	S	D	L	Miktar	Fiyat ₺
OMG-200020	20	3.4	20.3	350	85	50,430
OMG-250020	25	4.2	25.3	350	45	80,690
OMG-320020	32	5.4	32.3	350	22	121,040
OMG-400020	40	6.7	40.4	350	15	195,070

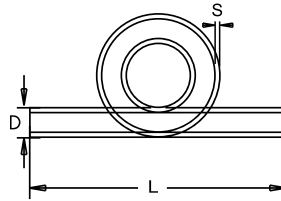

PP-R OMEGA PN 20

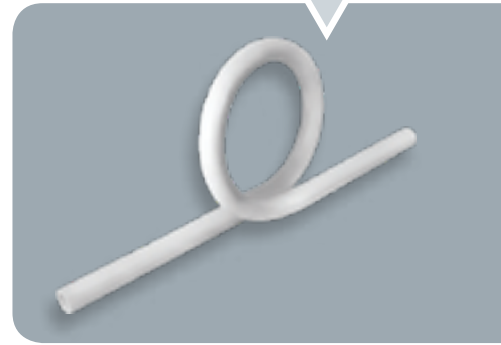

Kod	Ölçü (ø)	S	D	L	Miktar	Fiyat ₺
KVS-200020	20	3.4	20.3	350	160	12,570
KVS-250020	25	4.2	25.3	350	100	20,770
KVS-320020	32	5.4	32.3	350	65	43,250
KVS-400020	40	6.7	40.4	350	40	67,880

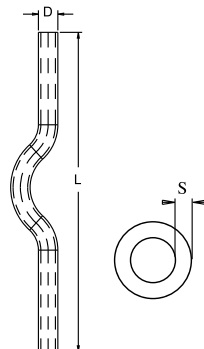

PP-R KAVİS PN 20



PP-R KAVİS MANŞONLU PN 25 - UZUN

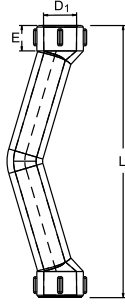

Kod	Ölçü (ø)	ø d ₁	E	L	Miktar	Fiyat ₺
MKV-200000	20	19.5	14.5	162	125	13,970
MKV-250000	25	24.5	16	200	80	22,110
MKV-320000	32	31.5	18	240	30	61,730

PP-R KAVİS MANŞONLU PN 25 - KISA (C TİP)

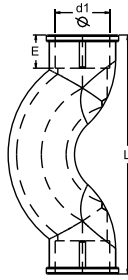

Kod	Ölçü (ø)	ø d ₁	E	L	Miktar	Fiyat ₺
MKK-200000	20	19.5	14.5	86	200	10,360
MKK-250000	25	24.5	16	95	125	17,040
MKK-320000	32	31.5	18	117	60	36,050

PP-R KAVİSLİ DİRSEK PN 25

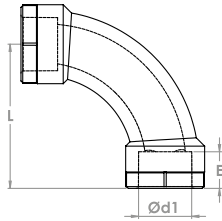

Kod	Ölçü (ø)	ø d ₁	E	L	Miktar	Fiyat ₺
KVD-250000	25	24.5	16	66	125	18,430
KVD-320000	32	31.5	18	83	60	38,570

PP-R UZUN TE PN 25

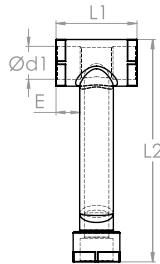

Kod	Ölçü (ø)	ø d ₁	E	L1	L2	Miktar	Fiyat ₺
MTK-200000	20	19.5	14.5	49	146	100	13,120
MTK-250000	25	24.5	16	59	163	70	15,740

PP-R MANŞON PN 25

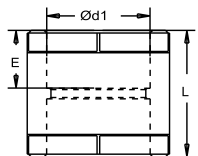

Kod	Ölçü (ø)	ø d ₁	E	L	Miktar	Fiyat ₺
MAN-200000	20	19.5	14.5	34	600	2,420
MAN-250000	25	24.5	16	37	300	4,010
MAN-320000	32	31.5	18	41	200	7,810
MAN-400000	40	39.4	20.5	45	100	13,030
MAN-500000	50	49.4	23.5	52	60	20,710
MAN-630000	63	62.5	27.5	60	36	39,180
MAN-750000	75	74.2	31	65	24	71,310
MAN-900000	90	89.2	35.5	71	16	115,260
MAN-1100000	110	109	41.5	79	6	194,160
MAN-1250000	125	123.9	46.5	104	4	364,230

Kod	Ölçü (ø)	Ø d1	Ø d2	E1	E2	L	Miktar	Fiyat ₺
RDM-252000	25/20	24.5	19.5	16	14.5	35	400	4,250
RDM-322000	32/20	31.5	19.5	18	14.5	38	300	6,790
RDM-322500	32/25	31.5	24.5	18	16	40	250	8,140
RDM-402000	40/20	39.4	19.5	20.5	14.5	47	150	15,910
RDM-402500	40/25	39.4	24.5	20.5	16	47	150	16,840
RDM-403200	40/32	39.4	31.5	20.5	18	47	125	18,730
RDM-502000	50/20	49.4	19.5	23.5	14.5	50	100	23,420
RDM-502500	50/25	49.4	24.5	23.5	16	50	100	24,360
RDM-503200	50/32	49.4	31.5	23.5	18	50	80	26,200
RDM-504000	50/40	49.4	39.4	23.5	20.5	50	75	28,090
RDM-632000	63/20	62.5	19.5	27.5	14.5	60	40	44,000
RDM-632500	63/25	62.5	24.5	27.5	16	60	40	44,930
RDM-633200	63/32	62.5	31.5	27.5	18	60	40	48,690
RDM-634000	63/40	62.5	39.4	27.5	20.5	65	40	50,560
RDM-635000	63/50	62.5	49.4	27.5	23.5	66	35	51,510

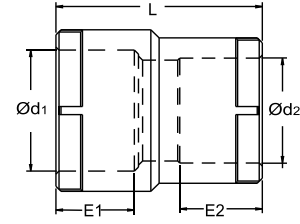
PP-R REDÜKSİYON MANŞON PN 25

Kod	Ölçü (ø)	Ø d1	E	D	L	Miktar	Fiyat ₺
RDS-252000	25/20	19.5	14.5	25	39	600	3,220
RDS-322000	32/20	19.5	14.5	32	39	400	4,070
RDS-322500	32/25	24.5	16	32	43	300	4,860
RDS-402000	40/20	19.5	14.5	40	39	200	8,260
RDS-402500	40/25	24.5	16	40	43	200	8,470
RDS-403200	40/32	31.5	18	40	48	150	9,450
RDS-502500	50/25	24.5	16	50	43	100	13,450
RDS-503200	50/32	31.5	18	50	48	100	14,610
RDS-504000	50/40	39.4	20.5	50	52	80	16,670
RDS-633200	63/32	31.5	18	63	48	60	33,040
RDS-634000	63/40	39.4	20.5	63	52	60	33,350
RDS-635000	63/50	49.4	23.5	63	60	50	37,080
RDS-754000	75/40	39.4	20.5	75	52	40	46,420
RDS-755000	75/50	49.4	23.5	75	60	40	46,420
RDS-756300	75/63	62.5	27.5	75	67	30	56,060
RDS-905000	90/50	49.4	23.5	90	60	20	86,590
RDS-906300	90/63	62.5	27.5	90	67	20	86,590
RDS-907500	90/75	74.2	31	90	72	16	94,030
RDS-116300	110/63	62.5	27.5	110	67	16	123,710
RDS-117500	110/75	74.2	31	110	72	16	123,710
RDS-119000	110/90	89.2	35.5	110	90	16	151,880
RDS-129000	125/90	89.2	35.5	125	120	6	332,960
RDS-121100	125/110	109	41.5	125	120	5	332,950

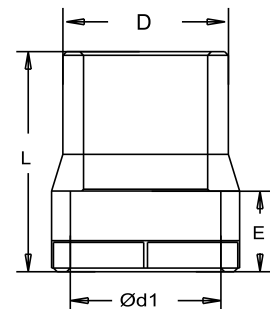
PP-R REDÜKSİYON PN 25

PP-R 90° REDÜKSİYON DİRSEK PN 25

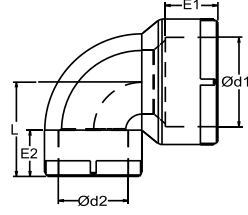

Kod	Ölçü (ø)	Ø d1	Ø d2	E1	E2	L	Miktar	Fiyat ₺
RDD-252000	25/20	24.5	19.5	16	14.5	29	250	6,800
RDD-322500	32/25	31.5	24.5	18	16	33	150	11,910

PP-R 90° KUYRUKLU DİRSEK PN 25

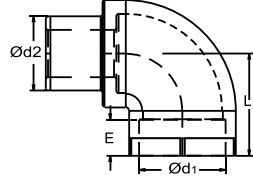

Kod	Ölçü (ø)	Ø d1	Ø d2	E	L	Miktar	Fiyat ₺
KDR-200090	20	19.5	20.3	14.5	23	300	6,590
KDR-250090	25	24.5	25.3	16	25	200	10,750
KDR-320090	32	31.5	32.3	18	28	100	16,610

PP-R 90° DİRSEK PN 25

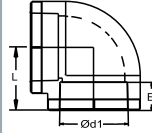

Kod	Ölçü (ø)	Ø d1	E	L	Miktar	Fiyat ₺
DIR-200090	20	19.5	14.5	23	400	3,460
DIR-250090	25	24.5	16	25	250	5,470
DIR-320090	32	31.5	18	28	125	10,360
DIR-400090	40	39.4	20.5	32	60	21,260
DIR-500090	50	49.4	23.5	37	35	37,960
DIR-630090	63	62.5	27.5	54	15	73,310
DIR-750090	75	74.2	31	60	12	104,170
DIR-900090	90	89.2	35.5	76	6	190,820
DIR-110090	110	109	41.5	94	2	325,570
DIR-125090	125	123.9	46.5	110	2	657,790

PP-R İNEĞAL TE PN 25

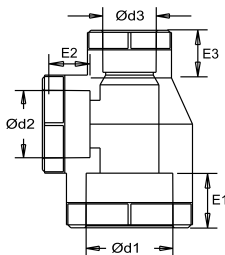

Kod	Ölçü (ø)	Ø d1	E1	Ø d2	E2	Ø d3	E3	Miktar	Fiyat ₺
ITE-202520	20/25/20	19.5	14.5	24.5	16	19.5	14.5	200	8,520
ITE-252020	25/20/20	24.5	16	19.5	14.5	19.5	14.5	150	8,500
ITE-252025	25/20/25	24.5	16	19.5	14.5	24.5	16	200	8,780
ITE-252520	25/25/20	24.5	16	24.5	16	19.5	14.5	150	9,080
ITE-322020	32/20/20	31.5	18	19.5	14.5	19.5	14.5	100	15,670
ITE-322025	32/20/25	31.5	18	19.5	14.5	24.5	16	100	13,510
ITE-322032	32/20/32	31.5	18	19.5	14.5	31.5	18	100	15,940
ITE-322520	32/25/20	31.5	18	24.5	16	19.5	14.5	100	13,330
ITE-322525	32/25/25	31.5	18	24.5	16	24.5	16.0	100	12,510
ITE-322532	32/25/32	31.5	18	24.5	16	31.5	18	100	16,340
ITE-402040	40/20/40	39.4	20.5	19.5	14.5	39.4	20.5	50	24,690
ITE-402540	40/25/40	39.4	20.5	24.5	16	39.4	20.5	50	25,780
ITE-403240	40/32/40	39.4	20.5	31.5	18	39.4	20.5	40	26,360
ITE-502050	50/20/50	49.4	23.5	19.5	14.5	49.4	23.5	30	50,170
ITE-502550	50/25/50	49.4	23.5	24.5	16	49.4	23.5	30	49,960
ITE-503250	50/32/50	49.4	23.5	31.5	18	49.4	23.5	30	49,870
ITE-504050	50/40/50	49.4	23.5	39.4	20.5	49.4	23.5	25	52,690
ITE-632063	63/20/63	62.5	27.5	19.5	14.5	62.5	27.5	24	93,250
ITE-632563	63/25/63	62.5	27.5	24.5	16	62.5	27.5	24	93,270
ITE-633263	63/32/63	62.5	27.5	31.5	18	62.5	27.5	24	95,940



Kod	Ölçü (ø)	Ø d1	E	Miktar	Fiyat ₺
DIR-200045	20	19.5	14.5	500	4,800
DIR-250045	25	24.5	16	300	6,990
DIR-320045	32	31.5	18	125	11,540
DIR-400045	40	39.4	20.5	80	20,230
DIR-500045	50	49.4	23.5	40	40,210
DIR-630045	63	62.5	27.5	20	71,950
DIR-750045	75	74.2	31	15	152,990
DIR-900045	90	89.2	35.5	8	290,760
DIR-110045	110	109	41.5	4	486,950

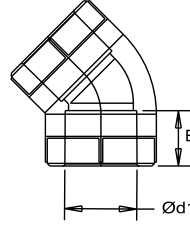

PP-R 45° DİRSEK PN 25



PP-R 45° KUYRUKLU DİRSEK PN 25

Kod	Ölçü (ø)	Ø d1	Ø d2	E	Miktar	Fiyat ₺
KDR-200045	20	19.5	20.3	14.5	300	5,010
KDR-250045	25	24.5	25.3	16	200	7,410
KDR-320045	32	31.5	32.3	18	100	13,850

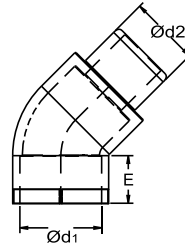

Kod	Ölçü (ø)	Ø d1	E	L	Miktar	Fiyat ₺
TEE-200000	20	19.5	14.5	52	250	5,280
TEE-250000	25	24.5	16	59	150	7,470
TEE-320000	32	31.5	18	70	80	15,030
TEE-400000	40	39.4	20.5	82	40	25,120
TEE-500000	50	49.4	23.5	100	25	49,840
TEE-630000	63	62.5	27.5	120	16	96,000
TEE-750000	75	74.2	31	137	10	153,670
TEE-900000	90	89.2	35.5	160	5	259,700
TEE-110000	110	109	41.5	190	2	434,900
TEE-125000	125	123.9	46.5	221	2	958,760

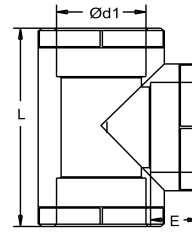

PP-R TE PN 25



Kod	Ölçü (ø)	Ø d1	E1	Ø d2	E2	Ø d3	E3	Miktar	Fiyat ₺
ITE-634063	63/40/63	62.5	27.5	39.4	20.5	62.5	27.5	16	97,940
ITE-635063	63/50/63	62.5	27.5	49.4	23.5	62.5	27.5	16	104,080
ITE-752075	75/20/75	74.2	31	19.5	14.5	74.2	31	10	212,400
ITE-752575	75/25/75	74.2	31	24.5	16	74.2	31	10	212,400
ITE-753275	75/32/75	74.2	31	31.5	18	74.2	31	10	200,240
ITE-754075	75/40/75	74.2	31	39.4	20.5	74.2	31	10	200,240
ITE-755075	75/50/75	74.2	31	49.4	23.5	74.2	31	10	200,240
ITE-756375	75/63/75	74.2	31	62.5	27.5	74.2	31	10	200,240
ITE-902590	90/25/90	89.2	35.5	24.5	16	89.2	35.5	5	360,430
ITE-903290	90/32/90	89.2	35.5	31.5	18	89.2	35.5	5	360,430
ITE-904090	90/40/90	89.2	35.5	39.4	20.5	89.2	35.5	5	343,280
ITE-905090	90/50/90	89.2	35.5	49.4	23.5	89.2	35.5	5	343,280
ITE-906390	90/63/90	89.2	35.5	62.5	27.5	89.2	35.5	5	343,280
ITE-907590	90/75/90	89.2	35.5	74.2	31	89.2	35.5	5	343,280
ITE-113211	110/32/110	109	41.5	31.5	18	109	41.5	2	572,860
ITE-114011	110/40/110	109	41.5	39.4	20.5	109	41.5	2	572,860
ITE-115011	110/50/110	109	41.5	49.4	23.5	109	41.5	2	543,520
ITE-116311	110/63/110	109	41.5	62.5	27.5	109	41.5	2	543,520
ITE-117511	110/75/110	109	41.5	74.2	31	109	41.5	2	543,520
ITE-119011	110/90/110	109	41.5	89.2	35.5	109	41.5	2	543,520
ITE-121112	125/110/125	123.9	46.5	109	41.5	123.9	46.5	2	1,072,740

PP-R İNEGAL TE PN 25

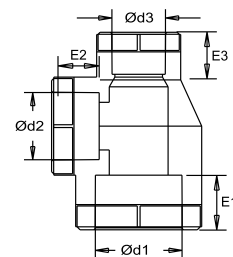

PP-R RADYATÖR BAYPAS PN 25

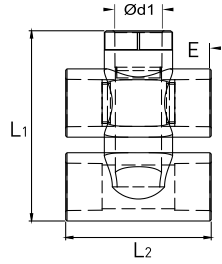

Kod	Ölçü (ø)	Ø d1	E	L1	L2	Miktar	Fiyat ₺
RBS-202000	20/20	19.5	14.5	78.3	60	100	22,300
RBS-252500	25/25	24.5	16	93	70	60	33,630

PP-R İSTAVROZ PN 25

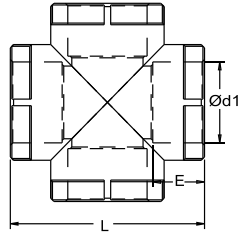

Kod	Ölçü (ø)	Ø d1	E	L	Miktar	Fiyat ₺
IST-200000	20	19.5	14.5	50	200	10,900
IST-250000	25	24.5	16	55	125	15,580
IST-320000	32	31.5	18	60	60	26,300
IST-400000	40	39.4	20.5	86	40	48,900

PP-R İNEGAL İSTAVROZ PN 25

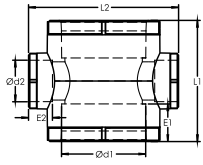

Kod	Ölçü (ø)	Ød1	Ød2	E1	E2	L1	L2	Miktar	Fiyat ₺
IIS-252000	25/20	24.5	19.5	16.0	14.5	56	56	150	18,450
IIS-322500	32/25	31.5	24.5	18	16.0	70	70	75	35,590
IIS-403200	40/32	39.4	31.5	20.5	18	86	86	40	52,730
IIS-502000	50/20	49.4	19.5	23.5	14.5	84	95	30	59,320
IIS-502500	50/25	49.4	24.5	23.5	16	84	95	30	64,260
IIS-503200	50/32	49.4	31.5	23.5	18	114	95	25	69,200
IIS-504000	50/40	49.4	39.4	23.5	20.5	114	95	25	74,150
IIS-632000	63/20	62.5	19.5	27.5	14.5	91	111	16	98,860
IIS-632500	63/25	62.5	24.5	27.5	16	91	111	16	108,750
IIS-633200	63/32	62.5	31.5	27.5	18	127	113	16	118,640
IIS-634000	63/40	62.5	39.4	27.5	20.5	127	113	16	128,520
IIS-635000	63/50	62.5	49.4	27.5	23.5	127	113	12	130,430

PP-R KÖŞE İSTAVROZ PN 25

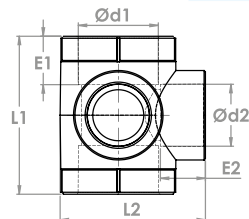

Kod	Ölçü (ø)	Ød1	Ød2	E1	E2	L1	L2	Miktar	Fiyat ₺
KIS-322000	32/20	31.5	19.5	18	14.5	62	57	80	23,110
KIS-322500	32/25	31.5	24.5	18	16	62	57	80	23,720
KIS-402000	40/20	39.4	19.5	20.5	14.5	66	60	60	34,830
KIS-402500	40/25	39.4	24.5	20.5	16	66	60	60	34,830



Kod	Ölçü (ø)	Ø d1	E	Miktar	Fiyat ₺
KPB-200000	20	19.5	14.5	750	3,070
KPB-250000	25	24.5	16	500	4,010
KPB-320000	32	31.5	18	250	6,990
KPB-400000	40	39.4	20.5	150	9,690
KPB-500000	50	49.4	23.5	80	17,520
KPB-630000	63	62.5	27.5	50	34,350
KPB-750000	75	74.2	31	25	67,700
KPB-900000	90	89.2	35.5	18	88,740
KPB-110000	110	109	41.5	9	191,970
KPB-125000	125	123.9	46.5	6	327,940

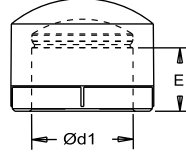

PP-R KAPAMA BAŞLIĞI PN 25



Kod	Ölçü (ø)	Ø d1	Ø d2	E	L	Miktar	Fiyat ₺
FLA-500000	50	49.4	65	23.5	32	80	49,780
FLA-630000	63	62.5	80	27.5	40	50	62,220
FLA-750000	75	74.2	95	31	40	40	116,150
FLA-900000	90	89.2	111	35.5	42	25	144,980
FLA-110000	110	109	132	41.5	49	12	191,020

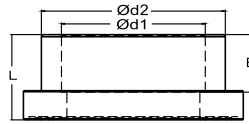

PP-R FLANŞ ADAPTÖRÜ



Kod	Ölçü (ø)	Ø d1	Ø d2	L	Miktar	Fiyat ₺
FLN-500000	50	66	17	109	30	149,330
FLN-630000	63	81	17	121	30	165,930
FLN-750000	75	97	17	144	16	290,580
FLN-900000	90	113	17	160	16	331,850
FLN-110000	110	133	17	180	12	414,810

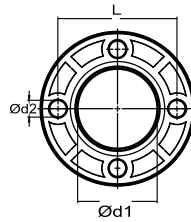

FLANŞ

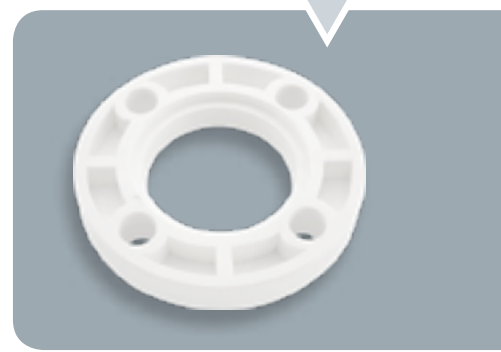

Kod	Ölçü (ø)	Ø d	L	E	Miktar	Fiyat ₺
UKT-200012	20 x 1/2"	20.3	56	5	750	4,940

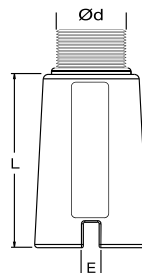

PP-R UZUN KÖRTAPA PN 25



PP-R KÖRTAPA PN 25

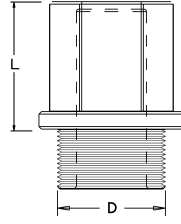

Kod	Ölçü (ø)	D	L	Miktar	Fiyat ₺
KTP-200012	20 x 1/2"	20.3	25	2500	3,090
KTP-250034	25 x 3/4"	26	15	2500	2,310



nature
serisi



CETVEL

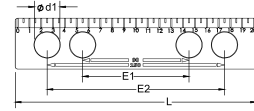

Kod	Ölçü (ø)	Ø d1	E1	E2	L	Miktar	Fiyat ₺
CTV-000000	1/2"	20.5	90	150	200	400	14,300

PP-R ERKEK İSTAVROZ PN 25

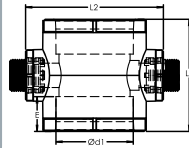

Kod	Ölçü (ø)	Ø d1	E	L1	L2	Miktar	Fiyat ₺
EIM-500012	50 x 1/2"	49.4	23.5	84	95	16	257,490
EIM-500034	50 x 3/4"	49.4	23.5	84	95	16	315,780
EIM-500100	50 x 1"	49.4	23.5	114	95	16	388,660
EIM-500114	50 x 1 1/4"	49.4	23.5	114	95	12	437,240
EIM-630012	63 x 1/2"	62.5	27.5	91	111	8	388,660
EIM-630034	63 x 3/4"	62.5	27.5	91	111	8	437,240
EIM-630100	63 x 1"	62.5	27.5	127	113	8	485,500
EIM-630114	63 x 1 1/4"	62.5	27.5	127	120	6	535,400

PP-R DIŞI İSTAVROZ PN 25

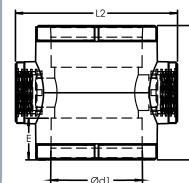

Kod	Ölçü (ø)	Ø d1	E	L1	L2	Miktar	Fiyat ₺
DIM-250012	25 x 1/2"	24.5	16	56	56	80	61,600
DIM-320034	32 x 3/4"	31.5	18	70	70	40	96,710
DIM-400034	40 x 3/4"	39.4	20.5	86	86	20	114,070
DIM-400100	40 x 1"	39.4	20.5	86	86	20	123,200
DIM-500012	50 x 1/2"	49.4	23.5	84	95	16	136,890
DIM-500034	50 x 3/4"	49.4	23.5	84	95	16	152,260
DIM-500100	50 x 1"	49.4	23.5	114	95	16	233,210
DIM-500114	50 x 1 1/4"	49.4	23.5	114	95	12	304,170
DIM-630012	63 x 1/2"	62.5	27.5	91	111	8	172,340
DIM-630034	63 x 3/4"	62.5	27.5	91	111	8	200,770
DIM-630100	63 x 1"	62.5	27.5	127	113	8	268,670
DIM-630114	63 x 1 1/4"	62.5	27.5	127	120	6	354,860



Kod	Ölçü (ø)	Ø d1	E	D	L	Miktar	Fiyat ₺
KBP-200000	20	19.5	14.5	20.3	22	300	21,900
KBP-250000	25	24.5	16	25.3	25	200	29,670
KBP-320000	32	31.5	18	32.3	30	100	62,590

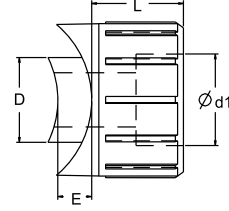

PP-R PLASTİK BRANŞMAN PN 25



Kod	Ölçü (ø)	D	E	L	Miktar	Fiyat ₺
EKB-200012	20 x 1/2"	20.3	14.5	40	150	51,110
EKB-250034	25 x 3/4"	25.3	16	42	100	79,850
EKB-320100	32 x 1"	32.3	18	44	50	143,730

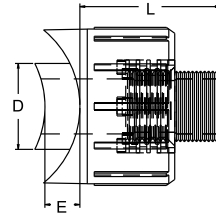

PP-R ERKEK BRANŞMAN PN 25



Kod	Ölçü (ø)	D	E	L	Miktar	Fiyat ₺
DKB-200012	20 x 1/2"	20.3	14.5	22	150	40,880
DKB-250034	25 x 3/4"	25.3	16	25	100	55,390
DKB-320100	32 x 1"	32.3	18	30	50	116,840

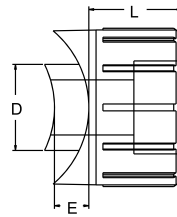

PP-R DIŞI BRANŞMAN PN 25



Kod	Ölçü (ø)	Ø d1	E	L	Miktar	Fiyat ₺
ENP-200012	20 x 1/2"	19.5	14.5	55	125	32,190
ENP-200034	20 x 3/4"	19.5	14.5	55	100	50,320
ENP-250012	25 x 1/2"	24.5	16	57	100	37,360
ENP-250034	25 x 3/4"	24.5	16	57	80	48,740
ENP-250100	25 x 1"	24.5	16	57	50	110,880
ENP-320012	32 x 1/2"	31.5	18	60	50	82,130
ENP-320034	32 x 3/4"	31.5	18	60	60	79,080
ENP-320100	32 x 1"	31.5	18	60	60	102,670

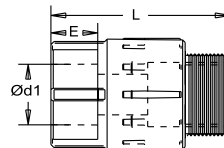

PP-R ERKEK NİPEL PN 25



PP-R ALTİKÖŞE ERKEK NİPEL PN 25

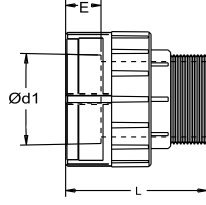

Kod	Ölçü (ø)	Ø d1	E	L	Miktar	Fiyat ₺
AEN-320100	32 x 1"	31.5	18	59	50	114,040
AEN-400100	40 x 1"	39.4	20.5	75	30	176,950
AEN-400114	40 x 1 1/4"	39.4	20.5	80	30	190,910
AEN-500112	50 x 1 1/2"	49.4	23.5	90	15	253,020
AEN-630200	63 x 2"	62.5	27.5	95	10	409,120
AEN-750212	75 x 2 1/2"	74.2	31	105	6	724,390
AEN-900300	90 x 3"	89.2	35.5	120	4	1.036,300
AEN-110400	110 x 4"	109	41.5	130	2	1.849,370
AEN-125500	125 x 5"	123.9	46.5	140	2	3.123,350

PP-R DIŞİ NİPEL PN 25

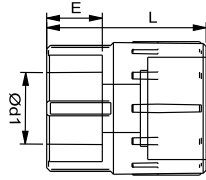

Kod	Ölçü (ø)	Ø d1	E	L	Miktar	Fiyat ₺
DNP-200012	20 x 1/2"	19.5	14.5	40	125	25,660
DNP-200034	20 x 3/4"	19.5	14.5	40	125	34,930
DNP-250012	25 x 1/2"	24.5	16	42	125	27,910
DNP-250034	25 x 3/4"	24.5	16	42	100	35,990
DNP-250100	25 x 1"	24.5	16	42	50	90,120
DNP-320012	32 x 1/2"	31.5	18	44	75	60,840
DNP-320034	32 x 3/4"	31.5	18	44	50	60,840
DNP-320100	32 x 1"	31.5	18	44	75	83,460

**30 yıldır 5 kıtada 80 ülkede,
profesyonellerin ilk tercihi**



snowdrop
serisi



Kod	Ölçü (ø)	Ø d1	E	L	Miktar	Fiyat ₺
ADN-320100	32 x 1"	31.5	18	55	60	92,200
ADN-400100	40 x 1"	39.4	20.5	60	30	138,680
ADN-400114	40 x 1 1/4"	39.4	20.5	65	30	145,840
ADN-500112	50 x 1 1/2"	49.4	23.5	70	20	185,410
ADN-630200	63 x 2"	62.5	27.5	75	10	345,980
ADN-750212	75 x 2 1/2"	74.2	31	80	8	576,460
ADN-900300	90 x 3"	89.2	35.5	105	6	832,240
ADN-110400	110 x 4"	109	41.5	110	2	1.316,870
ADN-125500	125 x 5"	123.9	46.5	130	2	2.671,610

PP-R ALTİKÖŞE DİŞİ NİPEL PN 25

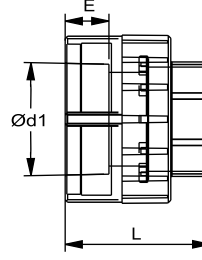

Kod	Ölçü (ø)	Ø d1	E	L	Miktar	Fiyat ₺
EDR-200012	20 x 1/2"	19.5	14.5	35	100	34,410
EDR-200034	20 x 3/4"	19.5	14.5	35	75	51,510
EDR-250012	25 x 1/2"	24.5	16	40	100	41,430
EDR-250034	25 x 3/4"	24.5	16	40	75	52,270
EDR-320012	32 x 1/2"	31.5	18	45	30	64,280
EDR-320034	32 x 3/4"	31.5	18	45	30	64,290
EDR-320100	32 x 1"	31.5	18	45	30	95,140

PP-R ERKEK DİRSEK PN 25

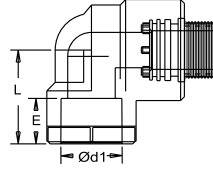

Kod	Ölçü (ø)	Ø d1	E	L	Miktar	Fiyat ₺
AED-320100	32 x 1"	31.5	18	38.5	30	98,790
AED-400114	40 x 1 1/4"	39.4	20.5	48.5	20	227,260
AED-500112	50 x 1 1/2"	49.4	23.5	59	12	288,120
AED-630200	63 x 2"	62.5	27.5	76.5	6	740,740

PP-R ALTİKÖŞE ERKEK DİRSEK PN 25

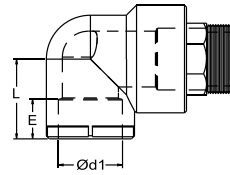

Kod	Ölçü (ø)	Ø d1	E	L	Miktar	Fiyat ₺
DDR-200012	20 x 1/2"	19.5	14.5	35	125	27,730
DDR-200034	20 x 3/4"	19.5	14.5	35	80	38,390
DDR-250012	25 x 1/2"	24.5	16	40	100	29,790
DDR-250034	25 x 3/4"	24.5	16	40	80	38,660
DDR-320012	32 x 1/2"	31.5	18	45	30	54,320
DDR-320034	32 x 3/4"	31.5	18	45	30	55,370
DDR-320100	32 x 1"	31.5	18	45	30	79,840

PP-R DİŞİ DİRSEK PN 25

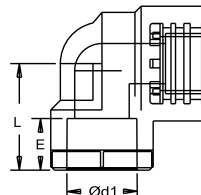

PP-R ALTİKÖŞE DİŞİ DİRSEK PN 25

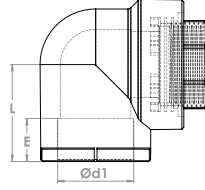

Kod	Ölçü (ø)	Ø d1	E	L	Miktar	Fiyat ₺
ADD-320100	32 x 1"	31.5	18	38.5	30	88,070
ADD-400114	40 x 1 1/4"	39.4	20.5	48.5	20	177,270
ADD-500112	50 x 1 1/2"	49.4	23.5	59	12	266,700
ADD-630200	63 x 2"	62.5	27.5	76.5	8	449,790

PP-R ERKEK BATARYA 3 AYAK PN 25

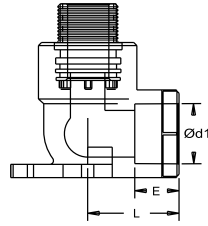

Kod	Ölçü (ø)	Ø d1	E	L	Miktar	Fiyat ₺
3EB-200012	20 x 1/2"	19.5	14.5	30	60	38,060
3EB-250012	25 x 1/2"	24.5	16	33	50	47,120

PP-R DİŞİ BATARYA 3 AYAK PN 25

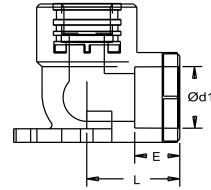

Kod	Ölçü (ø)	Ø d1	E	L	Miktar	Fiyat ₺
3DB-200012	20 x 1/2"	19.5	14.5	30	75	29,730
3DB-250012	25 x 1/2"	24.5	16	33	60	37,690

PP-R DİŞİ BATARYA 2 AYAK PN 25

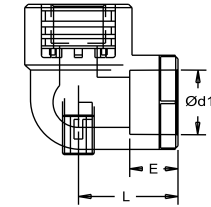

Kod	Ölçü (ø)	Ø d1	E	L	Miktar	Fiyat ₺
2DB-250034	25 x 3/4"	24.5	16	40	60	51,440

PP-R ASKILI BATARYA PN 25

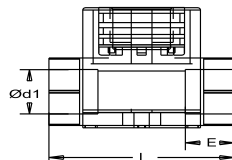

Kod	Ölçü (ø)	Ø d1	E	L	Miktar	Fiyat ₺
GBT-200012	20 x 1/2"	19.5	14.5	60	50	38,790



Kod	Ölçü (ø)	Ø d1	E	L	Miktar	Fiyat ₺
ECB-200012	20 x 1/2"	19.5	14.5	150	20	121,350
ECB-200034	20 x 3/4"	19.5	14.5	150	20	220,380
ECB-250012	25 x 1/2"	24.5	16	150	20	164,210
ECB-250034	25 x 3/4"	24.5	16	150	20	196,770

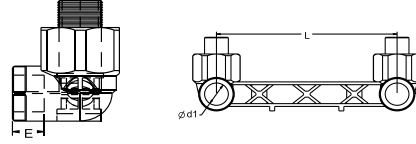

PP-R ERKEK ÇİFTLİ BATARYA BAĞLANTISI PN 25

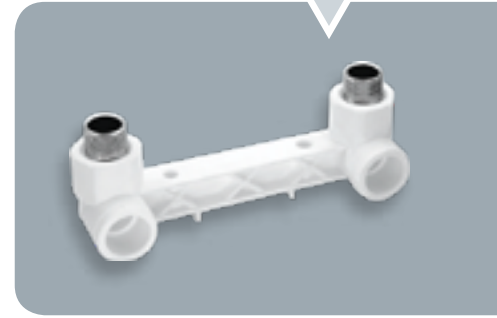

Kod	Ölçü (ø)	Ø d1	E	L	Miktar	Fiyat ₺
CBT-200012	20 x 1/2"	19.5	14.5	150	25	92,630
CBT-250012	25 x 1/2"	24.5	16	150	20	125,340

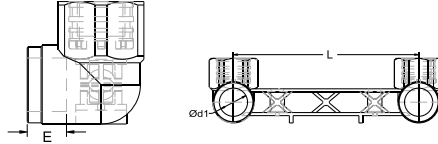

PP-R DIŞI ÇİFTLİ BATARYA BAĞLANTISI PN 25

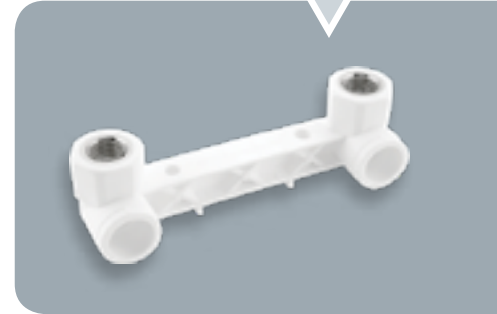

PP-R ERKEK ÇİFTLİ BATARYA BAĞLANTISI PN 25-LEVHA TİP

Kod	Ölçü (ø)	Ø d1	E	L	Miktar	Fiyat ₺
EBU-200012	20 x 1/2"	19.5	14.5	150	20	121,350
EBU-200034	20 x 3/4"	19.5	14.5	150	20	220,380
EBU-250012	25 x 1/2"	24.5	16	150	20	164,210
EBU-250034	25 x 3/4"	24.5	16	150	20	196,770

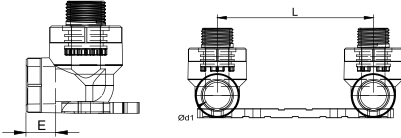

PP-R DIŞI ÇİFTLİ BATARYA BAĞLANTISI PN 25-LEVHA TİP

Kod	Ölçü (ø)	Ø d1	E	L	Miktar	Fiyat ₺
DBU-200012	20 x 1/2"	19.5	14.5	150	25	92,630
DBU-200034	20 x 3/4"	19.5	14.5	150	25	168,230
DBU-250012	25 x 1/2"	24.5	16	150	20	125,350
DBU-250034	25 x 3/4"	24.5	16	150	20	150,210

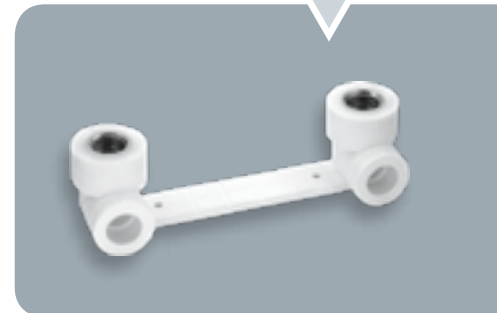
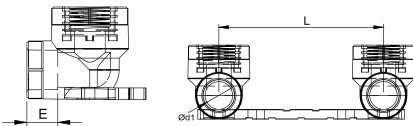

PP-R AYARLI BATARYA PN 25

Kod	Ölçü (ø)	Ø d1	E	L1	L2	L3	Miktar	Fiyat ₺
ABT-200012	20 x 1/2"	19.5	14.5	105	135	150	15	94,690
ABT-250012	25 x 1/2"	24.5	16	105	135	150	15	138,720

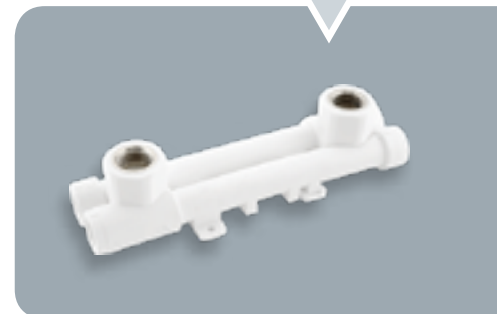
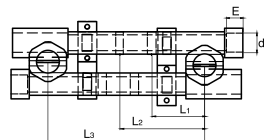

PP-R ERKEK TAHARET BAĞLANTISI PN 25 - ÇİFT GİRİŞ



Kod	Ölçü (ø)	Ø d1	E	L	Miktar	Fiyat ₺
EBK-200012	20 x 1/2"	19.5	14.5	100	30	109,050
EBK-200034	20 x 3/4"	19.5	14.5	100	30	162,140
EBK-250012	25 x 1/2"	24.5	16	100	25	130,330
EBK-250034	25 x 3/4"	24.5	16	100	25	154,320

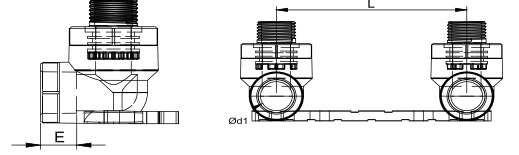

PP-R DIŞI TAHARET BAĞLANTISI PN 25 - ÇİFT GİRİŞ



Kod	Ölçü (ø)	Ø d1	E	L	Miktar	Fiyat ₺
DBK-200012	20 x 1/2"	19.5	14.5	100	30	79,270
DBK-250012	25 x 1/2"	24.5	16	100	25	101,800
DBK-250034	25 x 3/4"	24.5	16	100	25	122,220

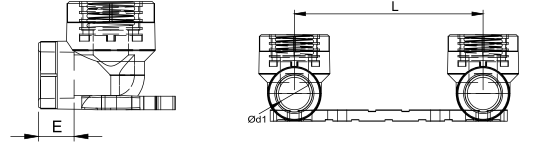

PP-R ERKEK TAHARET BAĞLANTISI PN 25



Kod	Ölçü (ø)	Ø d1	E	L	Miktar	Fiyat ₺
ETB-200012	20 x 1/2"	19.5	14.5	90	30	109,050
ETB-250012	25 x 1/2"	24.5	16	90	25	130,330

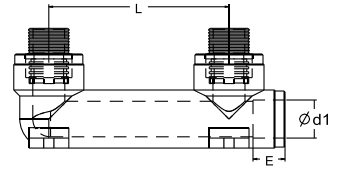

PP-R DIŞI TAHARET BAĞLANTISI PN 25



Kod	Ölçü (ø)	Ø d1	E	L	Miktar	Fiyat ₺
DTB-200012	20 x 1/2"	19.5	14.5	90	35	79,270
DTB-250012	25 x 1/2"	24.5	16	90	25	101,800

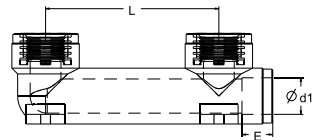

Kod	Ölçü (ø)	Ø d1	E	L	Miktar	Fiyat ₺
ETE-200012	20 x 1/2"	19.5	14.5	52	100	37,390
ETE-200034	20 x 3/4"	19.5	14.5	52	75	52,420
ETE-250012	25 x 1/2"	24.5	16	59	75	43,220
ETE-250034	25 x 3/4"	24.5	16	59	50	53,390
ETE-320012	32 x 1/2"	31.5	18	70	30	107,200
ETE-320034	32 x 3/4"	31.5	18	44	30	109,410
ETE-320100	32 x 1"	31.5	18	44	30	134,810
ETE-400012	40 x 1/2"	39.4	20.5	77	20	218,640
ETE-400034	40 x 3/4"	39.4	20.5	77	20	262,370
ETE-400100	40 x 1"	39.4	20.5	82	20	306,100
ETE-500012	50 x 1/2"	49.4	23.5	87	15	262,370
ETE-500034	50 x 3/4"	49.4	23.5	87	15	306,100
ETE-500100	50 x 1"	49.4	23.5	102	15	393,560
ETE-630012	63 x 1/2"	62.5	27.5	120	8	393,560
ETE-630034	63 x 3/4"	62.5	27.5	120	8	437,280
ETE-630100	63 x 1"	62.5	27.5	120	8	481,010

PP-R ERKEK TE PN 25

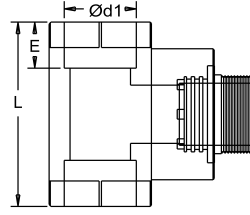

PP-R ALTİKÖŞE ERKEK TE PN 25

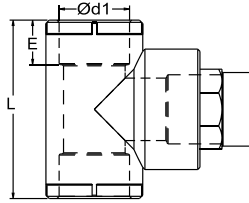

Kod	Ölçü (ø)	Ø d1	E	L	Miktar	Fiyat ₺
EAT-320100	32 x 1"	31.5	18	70	30	182,520
EAT-400114	40 x 1 1/4"	39.4	20.5	97.5	15	298,100
EAT-500112	50 x 1 1/2"	49.4	23.5	100	12	315,550
EAT-630200	63 x 2"	62.5	27.5	120	6	558,800

PP-R DIŞİ TE PN 25

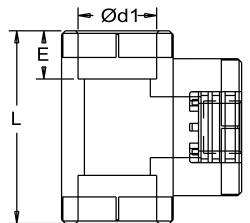

Kod	Ölçü (ø)	Ø d1	E	L	Miktar	Fiyat ₺
DTE-200012	20 x 1/2"	19.5	14.5	60	100	29,370
DTE-200034	20 x 3/4"	19.5	14.5	60	75	40,070
DTE-250012	25 x 1/2"	24.5	16	52	75	36,720
DTE-250034	25 x 3/4"	24.5	16	66	50	43,400
DTE-320012	32 x 1/2"	31.5	18	80	30	58,640
DTE-320034	32 x 3/4"	31.5	18	80	30	59,800
DTE-320100	32 x 1"	31.5	18	80	30	88,980
DTE-400012	40 x 1/2"	39.4	20.5	77	20	98,860
DTE-400034	40 x 3/4"	39.4	20.5	77	20	108,750
DTE-400100	40 x 1"	39.4	20.5	82	20	247,160
DTE-500012	50 x 1/2"	49.4	23.5	87	15	128,520
DTE-500034	50 x 3/4"	49.4	23.5	87	15	173,010
DTE-500100	50 x 1"	49.4	23.5	102	15	257,050
DTE-630012	63 x 1/2"	62.5	27.5	120	9	173,010
DTE-630034	63 x 3/4"	62.5	27.5	120	9	227,390
DTE-630100	63 x 1"	62.5	27.5	120	9	266,930

PP-R ALTİKÖŞE DİŞİ TE PN 25

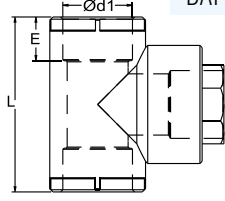

Kod	Ölçü (ø)	Ø d1	E	L	Miktar	Fiyat ₺
DAT-320100	32 x 1"	31.5	18	80	30	95,700
DAT-400114	40 x 1 1/4"	39.4	20.5	97.5	20	257,540
DAT-500112	50 x 1 1/2"	49.4	23.5	100	16	270,800
DAT-630200	63 x 2"	62.5	27.5	120	8	485,400

PP-R PLASTİK KÜRESEL VANA PN 25

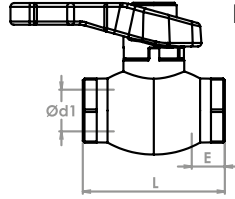

Kod	Ölçü (ø)	Ø d1	E	L	Miktar	Fiyat ₺
KSV-200012	20	19.5	14.5	66	50	62,820
KSV-250034	25	24.5	16	73	40	89,720
KSV-320100	32	31.5	18	88	20	179,400
KSV-400114	40	39.4	20.5	105	12	296,080
KSV-500112	50	49.4	23.5	125	8	493,460
KSV-630200	63	62.5	27.5	150	4	838,900
KSV-750212	75	74.2	31	165	4	1,085,620

PP-R PLASTİK KÜRESEL VANA PN 25 - EKO

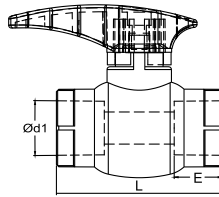

Kod	Ölçü (ø)	Ø d1	E	L	Miktar	Fiyat ₺
KVE-200000	20	19.5	14.5	59	90	53,840
KVE-250000	25	24.5	16	64	60	76,280
KVE-320000	32	31.5	18	75	40	116,660

PP-R PLASTİK KÜRESEL VANA PN 25 - EKO

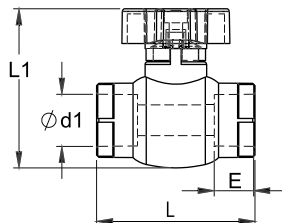

Kod	Ölçü (ø)	Ø d1	E	L	L1	Miktar	Fiyat ₺
KVE-200000-K	20	19.5	14.5	59	60	90	53,840
KVE-250000-K	25	24.5	16	64	65	60	76,280
KVE-320000-K	32	31.5	18	75	70	40	116,660

Kod	Ölçü (ø)	Ø d1	E	L	L1	Miktar	Fiyat ₺
SKV-200000	20	19.5	14.5	70	98	30	95,190
SKV-250000	25	24.5	16	75	102	20	133,890

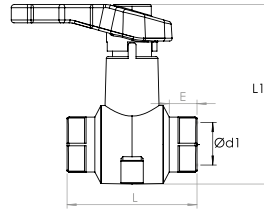

YENİ ÜRÜN

PP-R KÜRESEL VANA - SIVA ALTI



Kod	Ölçü (mm)	Ø d1	E	L	Miktar	Fiyat ₺
PBV-200000	20	19.5	14.5	85	40	234,500
PBV-250000	25	24.5	16	94	30	374,500
PBV-320000	32	31.5	18	100	20	498,200
PBV-400000	40	39.4	20.5	116	15	854,200
PBV-500000	50	49.4	23.5	131	9	1.196,300
PBV-630000	63	62.5	27.5	148	4	1.740,500

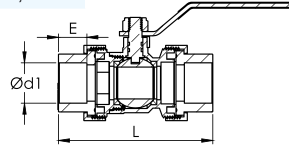

YENİ ÜRÜN

PP-R BAĞLANTILI METAL VANA



Kod	Ölçü (ø)	Ø d1	E	L	Miktar	Fiyat ₺
COK-200000	20	19.5	14.5	120	30	217,130
COK-250000	25	24.5	16	124	20	320,960
COK-320000	32	31.5	18	140	15	472,000

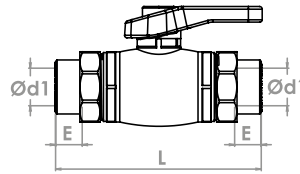

PP-R KÜRESEL VANA PN 25 - ÇİFT TARAFLI



Kod	Ölçü (ø)	Ø d1	E	L	Miktar	Fiyat ₺
DTV-200000	20	19.5	14.5	91	30	188,810
DTV-250000	25	24.5	16	95	25	273,780
DTV-320000	32	31.5	18	109	20	405,920

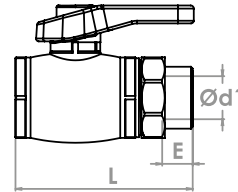

PP-R DIŞI KÜRESEL VANA PN 25 - TEK TARAFLI



Kod	Ölçü (ø)	Ø d1	E	L	Miktar	Fiyat ₺
TOK-200000	20	19.5	14.5	91	30	169,910
TOK-250000	25	24.5	16	95	25	226,560
TOK-320000	32	31.5	18	109	20	330,430

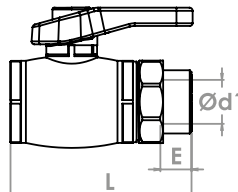

PP-R KÜRESEL VANA PN 25 - TEK TARAFLI



PP-R DIŞI KÜRESEL VANA PN 25

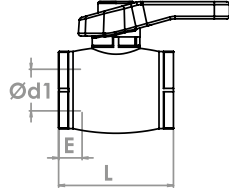

Kod	Ölçü (ø)	Ø d1	E	L	Miktar	Fiyat ₺
DKV-200012	20 x 1/2"	19.5	14.5	64	50	132,160
DKV-250034	25 x 3/4"	24.5	16	67	40	188,810
DKV-320100	32 x 1"	31.5	18	78	20	302,090

PP-R KOLLEKTÖR VANASI PN 25

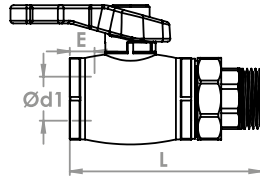

Kod	Ölçü (ø)	Ø d1	E	L	Miktar	Fiyat ₺
KTV-250100	25 x 1"	24.5	16	106	25	309,860
KTV-320100	32 x 1"	31.5	18	110	25	309,860

PP-R RADYATÖR VANASI PN 25 - DÜZ

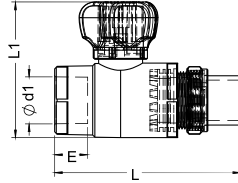

Kod	Ölçü (ø)	Ø d1	E	L	L1	Miktar	Fiyat ₺
KRN-200012	20 x 1/2"	19.5	14.5	89	67	50	112,310
KRN-250012	25 x 1/2"	24.5	16	89	67	50	140,190
KRN-250034	25 x 3/4"	24.5	16	94	72	40	173,210

PP-R RADYATÖR VANASI PN 25 - DİRSEKLİ

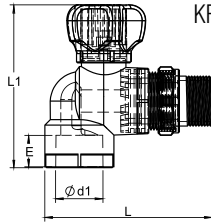

Kod	Ölçü (ø)	Ø d1	E	L	L1	Miktar	Fiyat ₺
KRD-200012	20 x 1/2"	19.5	14.5	87.5	83	50	112,310
KRD-250012	25 x 1/2"	24.5	16	87.5	83	50	140,190
KRD-250034	25 x 3/4"	24.5	16	91	90.5	40	173,210

PP-R OYNAR BAŞLI RADYATÖR NİPELİ PN 25

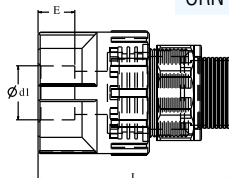

Kod	Ölçü (ø)	Ø d1	E	L	Miktar	Fiyat ₺
ORN-200012	20 x 1/2"	19.5	14.5	55	60	82,270
ORN-200034	20 x 3/4"	19.5	14.5	57	50	134,570
ORN-250012	25 x 1/2"	24.5	16	57	60	97,220
ORN-250034	25 x 3/4"	24.5	16	57	50	127,120

PP-R OYNAR BAŞLI RADYATÖR DİRSEĞİ PN 25

Kod	Ölçü (ø)	Ø d1	E	L	Miktar	Fiyat ₺
ORD-200012	20 x 1/2"	19.5	14.5	30	60	82,270
ORD-200034	20 x 3/4"	19.5	14.5	35	50	134,570
ORD-250012	25 x 1/2"	24.5	16	40	60	97,220
ORD-250034	25 x 3/4"	24.5	16	40	50	127,120

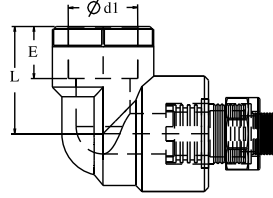

PP-R KELEBEK VANA PN 25

Kod	Ölçü (ø)	Ø d1	L	L1	E	Miktar	Fiyat ₺
KBV-200012	20	19.5	73	96	14.5	40	96,490
KBV-250034	25	24.5	73	105	16	30	113,130
KBV-320100	32	31.5	86	109	18	20	177,000
KBV-400114	40	39.4	93	129	20.5	15	231,790

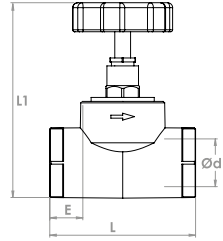

PP-R LÜX STOP VANA PN 25

Kod	Ölçü (ø)	Ø d1	E	L	L1	Miktar	Fiyat ₺
LSV-200000	20	19.5	14.5	73	138	15	181,240
LSV-250000	25	24.5	16	78	138	15	194,110
LSV-320000	32	31.5	18	87	143	15	208,100

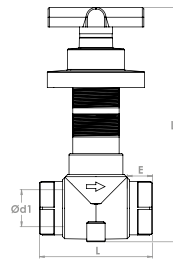

YENİ ÜRÜN



PP-R KROMLU ANKASTRE VANA PN 25

Kod	Ölçü (ø)	Ø d1	E	L	L1	Miktar	Fiyat ₺
KAV-200012	20	19.5	14.5	73	93	30	265,100
KAV-250034	25	24.5	16	73	94	25	309,630
KAV-320100	32	31.5	18	86	105	25	396,880
KAV-400114	40	39.4	20.5	93	107	20	466,960

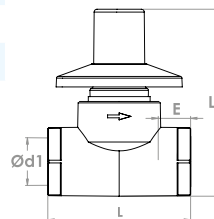

PP-R KROMLU VANA PN 25

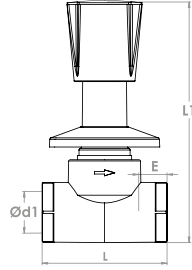

Kod	Ölçü (ø)	Ø d1	E	L	L1	Miktar	Fiyat ₺
KVZ-200012	20	19.5	14.5	73	138	25	318,250
KVZ-250034	25	24.5	16	73	141	20	354,000
KVZ-320100	32	31.5	18	86	151	15	466,520
KVZ-400114	40	39.4	20.5	93	157	10	505,160

PP-R KROMLU VANA PN 25 - MEVLANA

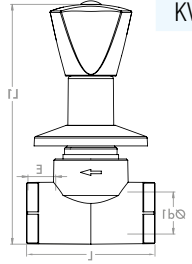

Kod	Ölçü (ø)	Ø d1	E	L	L1	Miktar	Fiyat ₺
KVZ-200012-M	20	19.5	14.5	73	131	25	318,250
KVZ-250034-M	25	24.5	16	73	137	20	354,000
KVZ-320100-M	32	31.5	18	86	147	15	466,520
KVZ-400114-M	40	39.4	20.5	93	153	10	505,160

PP-R KROMLU KÜRESEL VANA PN 25

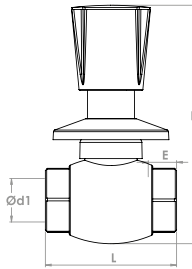

Kod	Ölçü (ø)	Ø d1	E	L	L1	Miktar	Fiyat ₺
KKV-200012	20	19.5	14.5	67	132	25	227,980
KKV-250034	25	24.5	16	74	138	20	285,070
KKV-320100	32	31.5	18	87	150	15	342,170

PP-R KROMLU KÜRESEL VANA PN 25 - MEVLANA

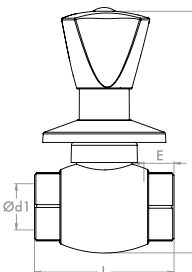

Kod	Ölçü (ø)	Ø d1	E	L	L1	Miktar	Fiyat ₺
KKV-200012-M	20	19.5	14.5	67	126	25	227,980
KKV-250034-M	25	24.5	16	74	133	20	285,070
KKV-320100-M	32	31.5	18	87	148	15	342,170

PP-R BAHÇE MUSLUĞU

Kod	Ölçü (R)	Ø d1	L	L1	Miktar	Fiyat ₺
BMS-200012	1/2"	13,6	74	63	40	101,390

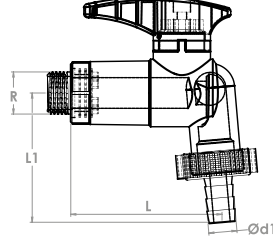
**PP-R ÇAMAŞIR MAKİNESİ MUSLUĞU**

Kod	Ölçü (R-R2)	L	L1	Miktar	Fiyat ₺
CMS-200000	1/2-3/4"	72	39	40	88,080

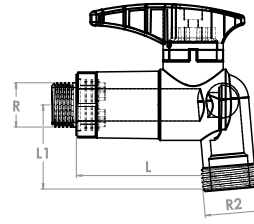
**ÇİFTLİ MUSLUK ÇATALI**

Kod	Ölçü (R)	Miktar	Fiyat ₺
MCT-000034	3/4"	100	33,860

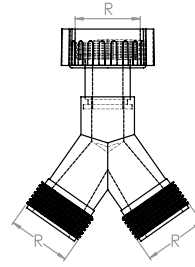
**PP-R ERKEK ÇEKVALF PN 25**

Kod	Ölçü (ø)	Ø d1	Ø d2	E	L	Miktar	Fiyat ₺
VEF-200012	20	19.5	20.3	14.5	67	75	55,030
VEF-250034	25	24.5	25.3	16	71	50	86,010
VEF-320100	32	31.5	32.3	18	100	25	139,400

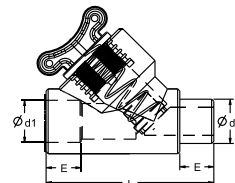

PP-R DIŞI ÇEKVALF PN 25

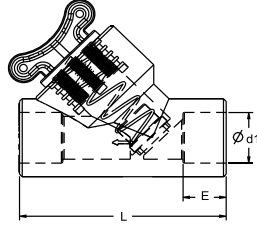

Kod	Ölçü (ø)	Ø d1	E	L	Miktar	Fiyat ₺
VDF-200012	20	19.5	14.5	67	75	55,030
VDF-250034	25	24.5	16	71	50	86,010
VDF-320100	32	31.5	18	100	25	139,400

PP-R ERKEK VANA PN 25

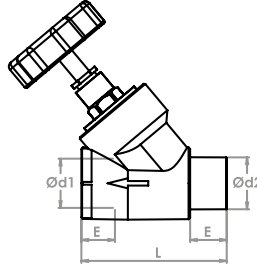

Kod	Ölçü (ø)	Ø d1	Ø d2	E	L	Miktar	Fiyat ₺
DDV-200012	20	19.5	20.3	14.5	78	30	149,120
DDV-250034	25	24.5	25.3	16	88	30	174,050
DDV-320100	32	31.5	32.3	18	106	15	296,080

PP-R DIŞI VANA PN 25

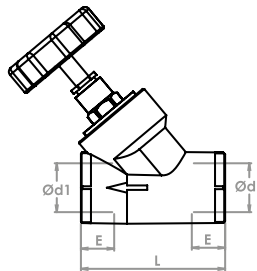

Kod	Ölçü (ø)	Ø d1	E	L	Miktar	Fiyat ₺
IDV-200012	20	19.5	14.5	78	30	149,120
IDV-250034	25	24.5	16	88	30	174,050
IDV-320100	32	31.5	18	106	15	296,080

PP-R ERKEK FİLTRE PN 25

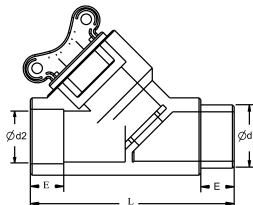

Kod	Ölçü (ø)	Ø d1	Ø d2	E	L	Miktar	Fiyat ₺
EFT-200012	20	20.3	19.5	14.5	78	75	55,030
EFT-250034	25	25.3	24.5	16	88	50	86,010
EFT-320100	32	32.3	31.5	18	106	25	139,400

Kod	Ölçü (ø)	Ø d1	E	L	Miktar	Fiyat ₺
DFT-200012	20	19.5	14.5	78	75	55,030
DFT-250034	25	24.5	16	88	50	86,010
DFT-320100	32	31.5	18	106	25	139,400

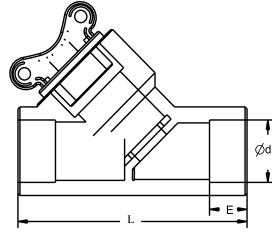

PP-R DIŞI FİLTRE PN 25



Kod	Ölçü (ø)	Ø d1	E	L	Miktar	Fiyat ₺
ENK-200012	20 x 1/2"	20.3	14.5	52	125	40,150
ENK-200034	20 x 3/4"	20.3	14.5	54	100	67,760
ENK-250012	25 x 1/2"	25.3	16	52	125	47,680
ENK-250034	25 x 3/4"	25.3	16	54	75	62,740

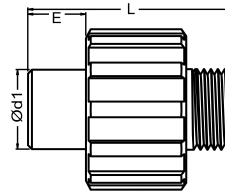

PP-R KUYRUKLU ERKEK NİPEL PN 25



Kod	Ölçü (ø)	Ø d1	E	L	Miktar	Fiyat ₺
DNK-200012	20 x 1/2"	20.3	14.5	41	150	32,120
DNK-200034	20 x 3/4"	20.3	14.5	41	150	46,860
DNK-250012	25 x 1/2"	25.3	16	41	150	36,820
DNK-250034	25 x 3/4"	25.3	16	41	150	43,490

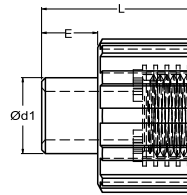

PP-R KUYRUKLU DIŞI NİPEL PN 25

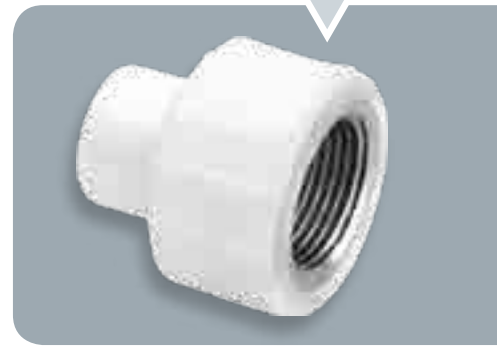

Kod	Ölçü (ø)	Ø d1	E	Miktar	Fiyat ₺
HNP-200012	20 x 1/2"	19.5	14.5	175	56,730
HNP-200034	20 x 3/4"	19.5	14.5	125	68,140
HNP-250012	25 x 1/2"	24.5	16	125	65,020
HNP-250034	25 x 3/4"	24.5	16	125	75,360
HNP-250100	25 x 1"	24.5	16	80	120,610
HNP-320034	32 x 3/4"	31.5	18	75	82,890
HNP-320100	32 x 1"	31.5	18	60	141,960
HNP-320114	32 x 1" 1/4"	31.5	18	50	177,450

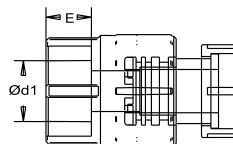

PP-R HAREKETLİ NİPEL PN 25



PP-R HAREKETLİ DİRSEK PN 25

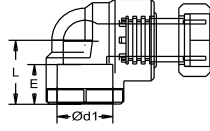

Kod	Ölçü (ø)	Ø d1	E	L	Miktar	Fiyat ₺
HDR-200012	20 x 1/2"	19.5	14.5	30	120	60,540
HDR-200034	20 x 3/4"	19.5	14.5	30	80	71,940
HDR-250034	25 x 3/4"	24.5	16	32	80	76,510
HDR-250100	25 x 1"	24.5	16	32	75	124,420
HDR-320034	32 x 3/4"	31.5	18	38	50	85,560
HDR-320100	32 x 1"	31.5	18	38	50	141,960
HDR-320114	32 x 1"1/4"	31.5	18	38	40	177,450

PP-R HAREKETLİ TE PN 25

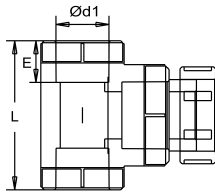

Kod	Ölçü (ø)	Ø d1	E	L	Miktar	Fiyat ₺
HTE-200012	20 x 1/2"	19.5	14.5	30	125	60,540
HTE-200034	20 x 3/4"	19.5	14.5	30	80	71,940
HTE-250034	25 x 3/4"	24.5	16	32	80	76,510
HTE-250100	25 x 1"	24.5	16	32	40	124,420
HTE-320100	32 x 1"	31.5	18	38	30	141,960
HTE-320114	32 x 1"1/4"	31.5	18	38	30	177,450

PP-R PE-X NİPELİ PN 25 - KUYRUKLU

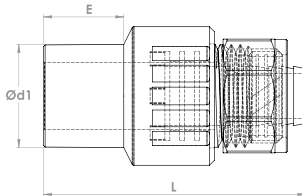

Kod	Ölçü (ø)	Ø d1	E	L	Miktar	Fiyat ₺
SPK-201216	20x1/2x16	20.3	14.5	54	200	75,450

PP-R OYNAR BAŞLI ERKEK RAKOR PN 25

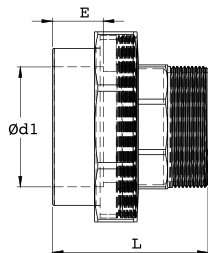

Kod	Ölçü (ø)	Ø d1	E	L	Miktar	Fiyat ₺
MOE-200012	20 x 1/2"	19.5	14.5	45	175	59,620
MOE-200034	20 x 3/4"	19.5	14.5	45	150	78,800
MOE-200100	20 x 1"	19.5	14.5	50	160	101,440
MOE-250012	25 x 1/2"	24.5	16	46	120	98,560
MOE-250034	25 x 3/4"	24.5	16	49	100	99,160
MOE-250100	25 x 1"	24.5	16	50	100	123,030
MOE-320012	32 x 1/2"	31.5	18	49	80	127,500
MOE-320034	32 x 3/4"	31.5	18	49	80	135,800
MOE-320100	32 x 1"	31.5	18	52	75	137,580
MOE-320114	32 x 1"1/4"	31.5	18	56	60	197,530
MOE-400114	40 x 1"1/4"	39.4	20.5	59	40	227,810
MOE-500112	50 x 1"1/2"	49.4	23.5	62	25	423,730
MOE-630200	63 x 2"	62.5	27.5	72	16	801,050
MOE-750212	75 x 2"1/2"	74.2	31	97	6	1,244,000
MOE-900300	90 x 3"	89.2	35.5	117	3	2,317,090
MOE-110400	110 x 4"	109	41.5	134	2	3,477,940

PP-R PE-X NİPELİ PN 25 - DIŞI

Kod	Ölçü (ø)	Ø d1	E	L	Miktar	Fiyat ₺
SPD-201216	20x1/2x16	19.5	14.5	54	200	75,450

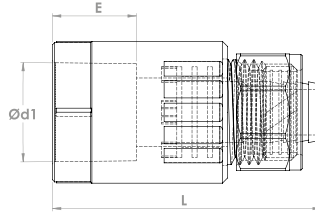

PP-R OYNAR BAŞLI DIŞI RAKOR PN 25

Kod	Ölçü (ø)	Ø d1	E	L	Miktar	Fiyat ₺
MOD-200012	20 x 1/2"	19.5	14.5	38	200	57,550
MOD-200034	20 x 3/4"	19.5	14.5	38	175	68,240
MOD-200100	20 x 1"	19.5	14.5	39	175	86,010
MOD-250012	25 x 1/2"	24.5	16	37	125	91,110
MOD-250034	25 x 3/4"	24.5	16	38	125	86,680
MOD-250100	25 x 1"	24.5	16	40	100	98,800
MOD-320012	32 x 1/2"	31.5	18	42	90	117,410
MOD-320034	32 x 3/4"	31.5	18	42	80	122,870
MOD-320100	32 x 1"	31.5	18	42	80	113,680
MOD-320114	32 x 1 1/4"	31.5	18	46	70	160,490
MOD-400114	40 x 1 1/4"	39.4	20.5	48	50	204,570
MOD-500112	50 x 1 1/2"	49.4	23.5	48	25	335,900
MOD-630200	63 x 2"	62.5	27.5	58	16	700,160
MOD-750212	75 x 2 1/2"	74.2	31	72	9	1.145,410
MOD-900300	90 x 3"	89.2	35.5	78	6	2.099,060
MOD-110400	110 x 4"	109	41.5	89	2	3.146,430

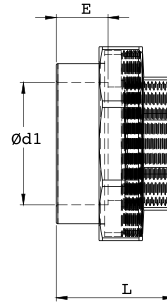

PP-R HAREKETLİ ERKEK NİPEL PN 25 - HAFİF TİP

Kod	Ölçü (ø)	Ø d1	L	Miktar	Fiyat ₺
ONE-200034	20 x 3/4"	20.3	38	200	22,050
ONE-250100	25 x 1"	25.3	43	150	40,310

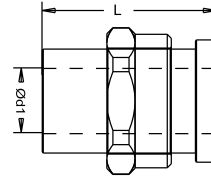

PP-R HAREKETLİ DIŞI NİPEL PN 25 - HAFİF TİP

Kod	Ölçü (ø)	Ø d1	L	Miktar	Fiyat ₺
OND-200034	20 x 3/4"	20.3	38	200	34,980
OND-250100	25 x 1"	25.3	43	150	52,890

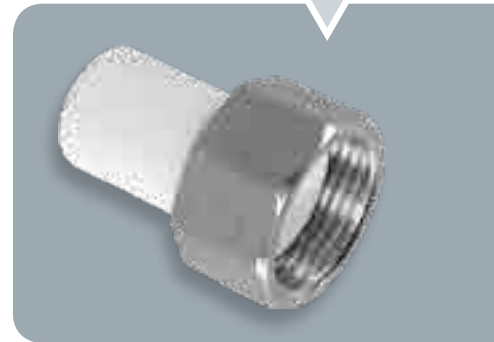
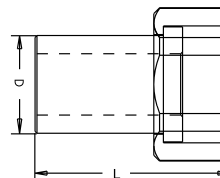

PP-R SU SAYAÇ NİPELİ PN 25

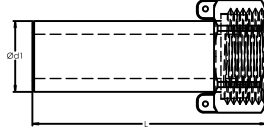

Kod	Ölçü (ø)	Ø d1	L1	Miktar	Fiyat ₺
SSB-200034	20 x 3/4"	20.3	68	175	34,980
SSB-250100	25 x 1"	25.3	68	150	52,890

PP-R ÇİFT TARAFLI KAYNAKLI RAKOR PN 25

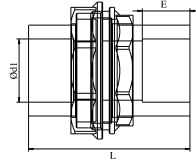

Kod	Ölçü (ø)	Ø d1	E	L	Miktar	Fiyat ₺
MCR-200000	20	19.5	14.5	56	100	90,370
MCR-250000	25	24.5	16	59	75	134,100
MCR-320000	32	31.5	18	60	50	166,170
MCR-400000	40	39.4	20.5	59	30	349,830
MCR-500000	50	49.4	23.5	59	25	542,230
MCR-630000	63	62.5	27.5	72	14	1.031,990

PP-R PLASTİK ÇİFT TARAFLI KAYNAKLI RAKOR PN 25

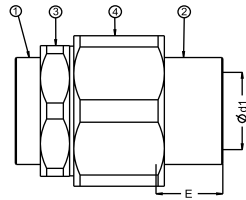

Kod	Ölçü (ø)	Ø d1	E	Miktar	Fiyat ₺
CKR-200000	20	19.5	14.5	100	45,670
CKR-250000	25	24.5	16	60	65,940
CKR-320000	32	31.5	18	80	91,290

PP-R PLASTİK ÇİFT TARAFLI KAYNAKLI RAKOR PN 16

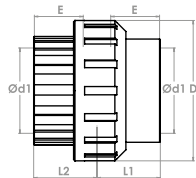

Kod	Ölçü (ø)	Ø d1	D	E	L1	L2	Miktar	Fiyat ₺
PKR-200000	20	19.5	43	14.5	21.5	24.3	200	33,710
PKR-250000	25	24.5	54	16	27.6	25.7	125	48,690
PKR-320000	32	31.5	60	18	25.2	30.1	80	67,420
PKR-400000	40	39.4	74	20.5	29	39	50	131,070
PKR-500000	50	49.4	92	23.5	34	45	30	187,240
PKR-630000	63	62.5	118	27.5	41	55	16	234,040
PKR-750000	75	74.2	130	31	47	53	10	734,040
PKR-900000	90	89.2	181	35.5	56	61	6	1.021,330
PKR-110000	110	109	210	41.5	65	71	3	1.340,530



Kod	Ölçü (ø)	Ø d1	E	L	Miktar	Fiyat ₺
POE-200012	20 x 1/2"	19.5	14.5	60	100	38,330
POE-250034	25 x 3/4"	24.5	16	65	70	55,360
POE-320100	32 x 1"	31.5	18	67	50	76,580

PP-R PLASTİK OYNAR BAŞLI ERKEK RAKOR PN 25

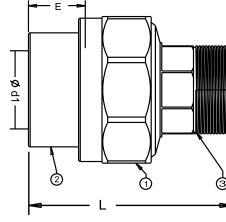

Kod	Ölçü (ø)	Ø d1	E	L	Miktar	Fiyat ₺
POD-200012	20 x 1/2"	19.5	14.5	50	100	38,330
POD-250034	25 x 3/4"	24.5	16	55	80	55,360
POD-320100	32 x 1"	31.5	18	57	60	76,580

PP-R PLASTİK OYNAR BAŞLI DIŞI RAKOR PN 25

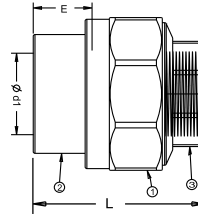

Kod	Kutu İçeriği	Miktar	Fiyat ₺
KHN-080000	PP-R Kombi Seti Hareketli Nipelli (8 Parça)	12	419,750
KHN-100000	PP-R Kombi Seti Hareketli Nipelli (10 Parça)	12	559,670
KHD-080000	PP-R Kombi Seti Hareketli Dirsekli (8 Parça)	12	419,750
KHD-100000	PP-R Kombi Seti Hareketli Dirsekli (10 Parça)	12	559,670

PP-R KOMBİ SETİ



Kod	Kutu İçeriği	Miktar	Fiyat ₺
EKN-080000	PP-R Kombi Seti Hareketli Nipelli (8 Parça)	12	377,780
EKN-100000	PP-R Kombi Seti Hareketli Nipelli (10 Parça)	12	468,720
EKD-080000	PP-R Kombi Seti Hareketli Dirsekli (8 Parça)	12	377,780
EKD-100000	PP-R Kombi Seti Hareketli Dirsekli (10 Parça)	12	468,720

PP-R KOMBİ SETİ (Ekonomik)





Yeşil **FORMÜL**
Yeşil **DOĞA**



formül[®]

**ISITMA GRUBU
ve VANALAR**

3

PE-RT BORU



Kod	Ölçü	Miktar	Fiyat ₺
PRT-160000	16 x 2 mm	160	21,500

KILIFLI PE-RT BORU



Kod	Ölçü	Miktar	Fiyat ₺
PRK-160000 Kırmızı	16 x 2 mm	100	34,500
PRK-160000 Mavi	16 x 2 mm	100	34,500

OKSİJEN BARIYERLİ PE-RT BORU



Kod	Ölçü	Miktar	Fiyat ₺
PRB-160000	16 x 2 mm	160	25,000

KILIFLI OKSİJEN BARIYERLİ PE-RT BORU



Kod	Ölçü	Miktar	Fiyat ₺
PBK-160000 Kırmızı	16 x 2 mm	100	37,500
PBK-160000 Mavi	16 x 2 mm	100	37,500

PP-R PE-X NİPELİ PN 25 - KUYRUKLU



Kod	Ölçü (ø)	Ø d1	E	L	Miktar	Fiyat ₺
SPK-201216	20x1/2x16	20.3	14.5	54	200	75,450

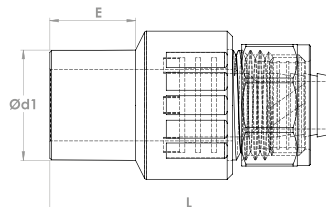

Kod	Ölçü (ø)	Ø d1	E	L	Miktar	Fiyat ₺
SPD-201216	20x1/2x16	19.5	14.5	54	200	75,450

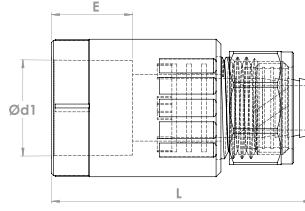

Kod	Ölçü	Miktar	Fiyat ₺
KRV-000012	1/2"	100	155,060

Kod	Ölçü	Miktar	Fiyat ₺
KRP-000012	1/2"	100	188,150

Kod	Ölçü	Miktar	Fiyat ₺
DRV-000012	1/2"	100	225,190

Kod	Ölçü	Miktar	Fiyat ₺
DRP-000012	1/2"	100	282,470

PP-R PE-X NİPELİ PN 25 - DIŞI**KÖŞE RADYATÖR VANASI****KÖŞE RADYATÖR VANASI PEX, PE-RT****DÜZ RADYATÖR VANASI****DÜZ RADYATÖR VANASI PE-RT**

KÜRESEL DOĞALGAZ VANASI



Kod	Ölçü	Miktar	Fiyat ₺
KDV-000012	1/2"	100	179,260
KDV-000034	3/4"	75	290,370
KDV-000100	1"	50	441,980
KDV-000114	1 1/4"	25	681,480
KDV-000112	1 1/2"	16	950,120
KDV-000200	2"	12	1.331,360

KÜRESEL VANA



Kod	Ölçü	Miktar	Fiyat ₺
KVP-010012	1/2"	125	162,960
KVP-010034	3/4"	100	239,010
KVP-010100	1"	60	379,260
KVP-010114	1 1/4"	40	621,230
KVP-010112	1 1/2"	24	841,480
KVP-010200	2"	15	1.170,370

KÜRESEL VANA KELEBEK KOLLU - RAKORLU



Kod	Ölçü	Miktar	Fiyat ₺
KKK-000100	1" Mavi	50	385,190
KKK-000100	1" Kırmızı	50	385,190

KALORİMETRE RAKORLU VANA

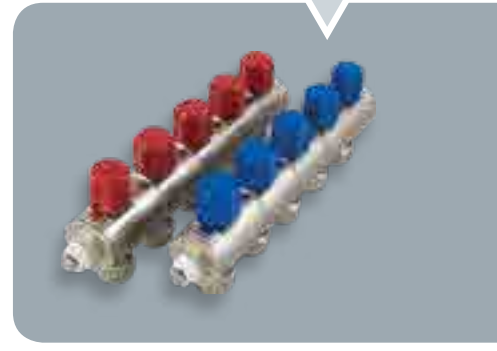

Kod	Ölçü	Miktar	Fiyat ₺
KLV-000100	1" Mavi	50	455,310
KLV-000100	1" Kırmızı	50	455,310

KENDİNDEN VANALI KOLLEKTÖR

Kod	Ölçü	Miktar	Fiyat ₺
VKL-020100	1" 2 Ağızlı	50	367,410
VKL-030100	1" 3 Ağızlı	36	551,110
VKL-040100	1" 4 Ağızlı	24	732,840
VKL-050100	1" 5 Ağızlı	20	916,540
VKL-060100	1" 6 Ağızlı	18	1.100,250
VKL-070100	1" 7 Ağızlı	16	1.281,980
VKL-080100	1" 8 Ağızlı	14	1.467,650
VKL-090100	1" 9 Ağızlı	12	1.651,360
VKL-100100	1" 10 Ağızlı	12	1.837,040
VKL-110100	1" 11 Ağızlı	12	2.016,790
VKL-120100	1" 12 Ağızlı	12	2.253,830
VKL-130100	1" 13 Ağızlı	10	2.382,220

PP-R KOLLEKTÖR VANASI PN 25

Kod	Ölçü (ø)	Ø d1	E	L	Miktar	Fiyat ₺
KTV-250100	25 x 1"	24.5	16	106	25	309,860
KTV-320100	32 x 1"	31.5	18	110	25	309,860

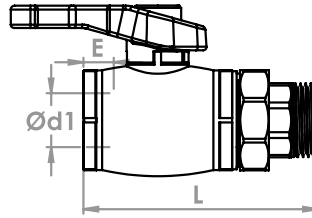

Kod	Ölçü	Miktar	Fiyat ₺
KLK-000100	1"	50	43,460

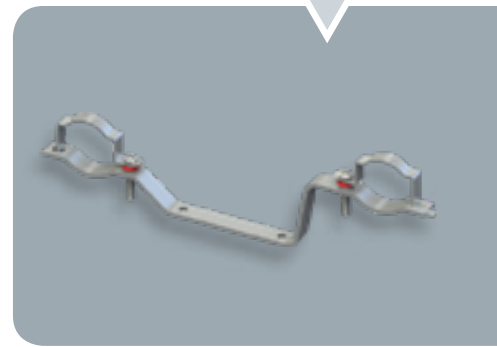
KOLLEKTÖR KELEPÇESİ

Çocuklarımıza **YAŞANABİLİR**
bir dünya bırakalım.



formül[®]

**AKSESUAR
GRUBU**

4

PP-R ATIK SU KELEPÇESİ

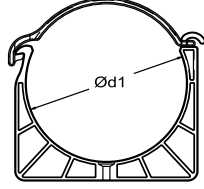

Kod	Ölçü (ø)	Ø d1	Miktar	Fiyat ₺
ATK-050000	50	50	250	5,550
ATK-075000	75	75	100	8,640
ATK-110000	110	110	130	14,450
ATK-125000	125	125	100	23,050
ATK-160000	160	160	75	35,390
ATK-200000	200	200	35	65,000

PP-R PLASTİK DERE KELEPÇESİ - PLASTİK ASKILI

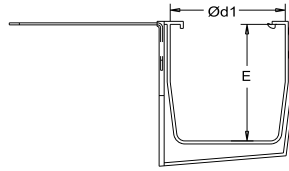

Kod	Ölçü (ø)	Ø d1	E	Miktar	Fiyat ₺
PDK-150000	150	150	150	75	17,700

PP-R PLASTİK DERE KELEPÇESİ-METAL ASKILI

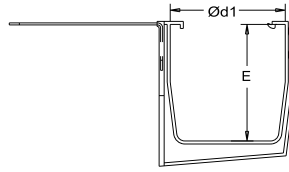

Kod	Ölçü (ø)	Ø d1	E	Miktar	Fiyat ₺
MDK-150000	150	150	150	75	44,600

PP-R DEK. PLASTİK DERE KELEPÇESİ - PLASTİK ASKILI

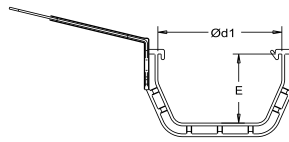
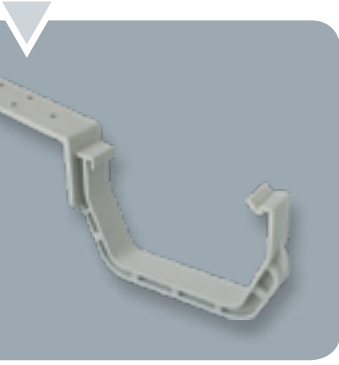

Kod	Ölçü (ø)	Ø d1	E	Miktar	Fiyat ₺
PDK-125000	125	125	75	100	14,740

PP-R DEK. PLASTİK DERE KELEPÇESİ METAL ASKILI

Kod	Ölçü (ø)	Ø d1	E	Miktar	Fiyat ₺
MDK-125000	125	125	75	100	40,000

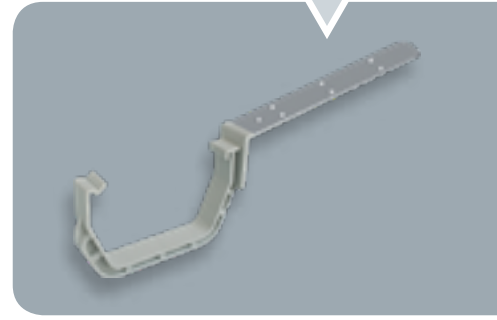
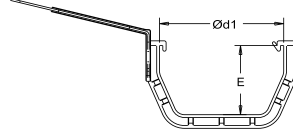

Kod	Ölçü (ø)	Ø d1	E	Miktar	Fiyat ₺
PIK-100000	100	100	75	100	13,330

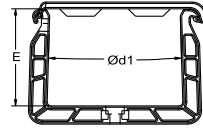
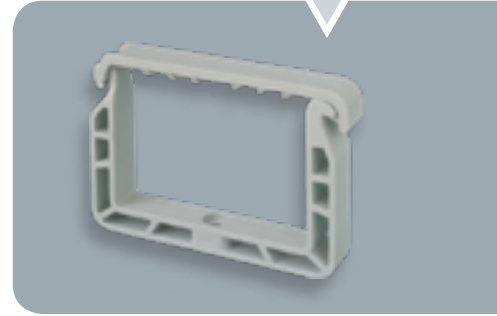
**PP-R PROFİL İNİŞ KELEPÇESİ**

Kod	Ölçü (ø)	Ø d1	L	Miktar	Fiyat ₺
TKP-200000	20	20	32	3000	1,350
TKP-250000	25	25	39	2500	1,720
TKP-320000	32	32	46	1800	2,520
TKP-400000	40	40	54	1400	3,500

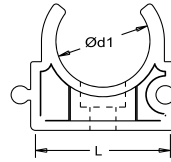
**PP-R TEKLİ KELEPÇE**

Kod	Ölçü (ø)	Ø d1	L	Miktar	Fiyat ₺
KPK-160000	16	16	28	2500	1,350
KPK-200000	20	20	32	2000	1,700
KPK-250000	25	25	37	2000	2,000
KPK-320000	32	32	44	1000	3,200
KPK-400000	40	40	52	750	4,500
KPK-500000	50	50	62	500	7,000

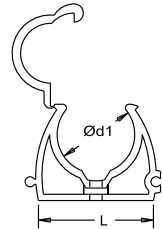
**PP-R KAPAKLI KELEPÇE**

Kod	Ölçü (ø)	Ø d1	Ø d2	E	Miktar	Fiyat ₺
DTK-200000	20	20	8	28	2000	1,860
DTK-250000	25	25	8	28	1500	2,040
DTK-320000	32	32	8	28	1000	2,720

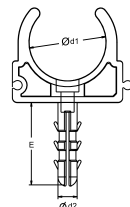
**PP-R DÜBELLİ TEKLİ KELEPÇE**

PP-R ÇİFTLİ KELEPÇE



Kod	Ölçü (ø)	Ø d1	L	Miktar	Fiyat ₺
CKP-202200	20-22	20-22	60	1800	2,420
CKP-252700	25-27	25-27	65	1500	3,150
CKP-323400	32-34	32-34	72	750	4,600

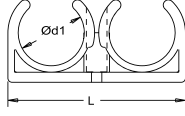

PP-R DÜBELLİ ÇİFTLİ KELEPÇE



Kod	Ölçü (ø)	Ø d1	Ø d2	E	Miktar	Fiyat ₺
CDK-200000	20	20	8	28	2000	2,260
CDK-250000	25	25	8	28	1200	3,180
CDK-320000	32	32	8	28	750	4,970

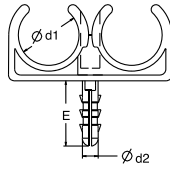

PP-R DÜBELLİ ÇİFTLİ KROŞE



Kod	Ölçü (ø)	Ø d1	Ø d2	E	Miktar	Fiyat ₺
DCK-250000	25	25	8	28	1000	2,710

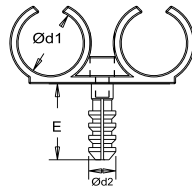

PP-R ÇİFTLİ KROŞE



Kod	Ölçü (ø)	Ø d1	Miktar	Fiyat ₺
CTK-250000	25	22	2500	1,490

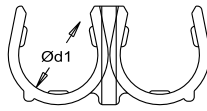

PP-R KÖŞE DÜZELTİCİ



Kod	Ø d1	L	Miktar	Fiyat ₺
KDZ-180000	18	90	200	6,000

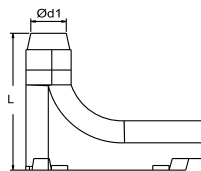

PP-R PLASTİK DÜBEL

Kod	Ölçü (ø)	Ø d1	L	Miktar	Fiyat ₺
PDB-060000	M6	6	30	30000	0,250
PDB-080000	M8	8	45	10000	0,430
PDB-100000	M10	10	60	5000	0,660

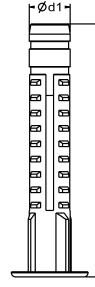

ROKET DÜBEL

Kod	Ölçü (ø)	Ø d1	L	Miktar	Fiyat ₺
RDB-080000	M8	8	51	10000	0,460
RDB-100000	M10	10	61	6000	0,650

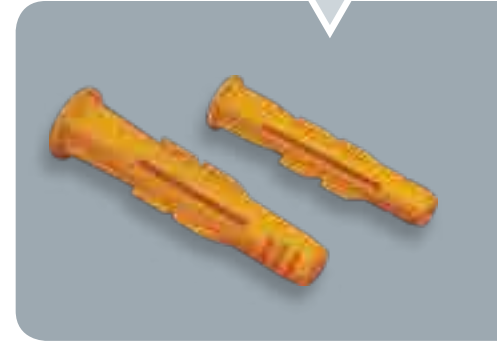
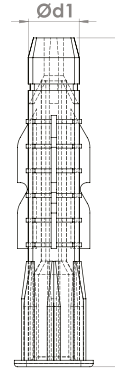

PP-R ÇİFTLİ YERE TESPİT DÜBELİ

Kod	Ölçü (ø)	Ø d1	L	Miktar	Fiyat ₺
YTC-250000	25	22	58	4000	0,560

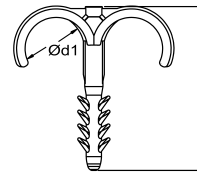

PP-R TEKLİ YERE TESPİT DÜBELİ

Kod	Ölçü (ø)	Ø d1	L	Miktar	Fiyat ₺
TYT-250000	25	22	56	8000	0,510

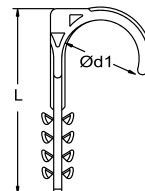

PP-R KLİPSLİ LAMA



Kod	Ø d1	L1	L2	Miktar	Fiyat ₺
KPL-160000	16	17.5	360	350	6,390

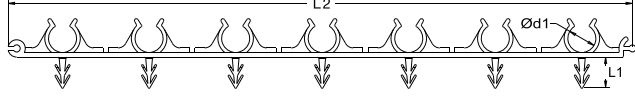

PP-R BORU TUTUCU

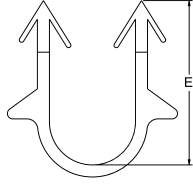

Kod	Ölçü (ø)	E	Miktar	Fiyat ₺
BRT-200000	20	36	8000	0,430

PP-R LAMA TUTUCU

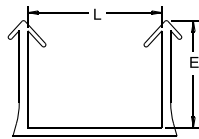

Kod	Ölçü (ø)	L	E	Miktar	Fiyat ₺
LMT-240000	24	24	24	8000	0,430

PP-R BORU GEÇİŞİ



Kod	Ölçü (ø)	Miktar	Fiyat ₺
BGS-000034	25 x 3/4"	175	11,880
BGS-000100	32 x 1"	140	14,070

PP-R BORU TAPASI**DOĞALGAZ MENFEZİ****KADA****ADAPTÖR CONTA**

Kod	Miktar	Fiyat ₺
BTP-161700	5000	0,490

Kod	Miktar	Fiyat ₺
DMZ-000000	100	26,800

Kod	Ölçü (ø)	Miktar	Fiyat ₺
EKK-110000	110	150 Adet / Çuval	55,000

Kod	Ölçü (ø)	Miktar	Fiyat ₺
ADC-050000	50	750 Adet / Çuval	5,400

ROT

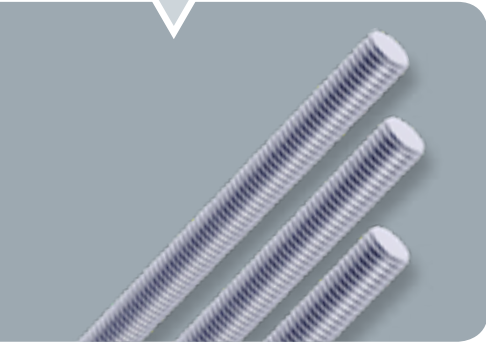

Kod	Ölçü (σ)	\varnothing d1	Miktar	Fiyat ₺
ROT-080000	M8	8	100	44,440
ROT-100000	M10	10	100	70,320
ROT-120000	M12	12	100	94,620

ÇAKMALI DÜBEL



Kod	Ölçü (σ)	Miktar	Fiyat ₺
CKD-080000	M8	100	15,470
CKD-100000	M10	100	21,070
CKD-120000	M12	100	27,130

ÇEKME Lİ DÜBEL



Kod	Ölçü (σ)	Miktar	Fiyat ₺
CMD-080000	M8	100	7,570
CMD-100000	M10	100	12,310
CMD-120000	M12	100	21,300

GÖMLEKLİ DÜBEL

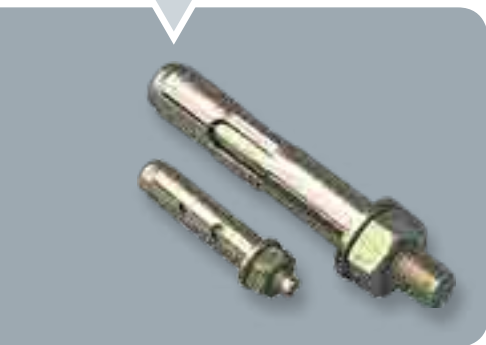

Kod	Ölçü (σ)	Miktar	Fiyat ₺
GMD-080000	M8	100	8,350
GMD-100000	M10	100	13,500
GMD-120000	M12	100	31,900

Kod	Ölçü (ø)	Ø d1	R	Miktar	Fiyat ₺
SMK-000038	3/8"	3/8	8 Rod	275	9,200
SMK-000012	1/2"	1/2	8 Rod	200	9,200
SMK-000034	3/4"	3/4	8 Rod	200	9,770
SMK-000100	1"	1	8 Rod	150	10,960
SMK-000114	1 1/4"	1 1/4	8 Rod	125	13,270
SMK-000112	1 1/2"	1 1/2	8 Rod	100	14,510
SMK-000200	2"	2	8 Rod	75	16,720
SMK-000212	2 1/2"	2 1/2	10 Rod	60	29,890
SMK-000300	3"	3	10 Rod	60	33,080
SMK-000312	3 1/2"	3 1/2	10 Rod	60	41,980
SMK-000400	4"	4	10 Rod	60	39,250
SMK-000412	4 1/2"	4 1/2	10 Rod	50	58,380
SMK-000500	5"	5	10 Rod	40	55,920
SMK-000512	5 1/2"	5 1/2	10 Rod	50	68,060
SMK-000600	6"	6	10 Rod	50	64,920
SMK-000800	8"	8	12 Rod	35	81,220
SMK-001000	10"	10	12 Rod	10	113,170

Kod	Ölçü (ø)	Ø d1	L	Miktar	Fiyat ₺
TSK-000038	3/8"	3/8	70	200	9,670
TSK-000012	1/2"	1/2	70	150	9,930
TSK-000034	3/4"	3/4	70	100	10,700
TSK-000100	1"	1	70	100	11,630
TSK-000114	1 1/4"	1 1/4	70	150	14,350
TSK-000112	1 1/2"	1 1/2	70	125	15,530
TSK-000200	2"	2	70	100	17,700
TSK-000212	2 1/2"	2 1/2	70	50	29,890
TSK-000300	3"	3	70	40	33,640
TSK-000312	3 1/2"	3 1/2	70	35	43,160
TSK-000400	4"	4	70	30	41,980
TSK-000412	4 1/2"	4 1/2	70	30	58,280
TSK-000500	5"	5	70	30	56,940

Kod	Ölçü (ø)	Ø d1	L	Miktar	Fiyat ₺
TUK-000038	3/8"	3/8	100	200	11,210
TUK-000012	1/2"	1/2	100	125	11,210
TUK-000034	3/4"	3/4	100	100	11,990
TUK-000100	1"	1	100	75	12,860
TUK-000114	1 1/4"	1 1/4	100	125	15,900
TUK-000112	1 1/2"	1 1/2	100	100	16,980
TUK-000200	2"	2	100	75	19,700
TUK-000212	2 1/2"	2 1/2	100	50	31,580
TUK-000300	3"	3	100	40	41,260
TUK-000312	3 1/2"	3 1/2	100	35	45,010
TUK-000400	4"	4	100	30	45,320
TUK-000412	4 1/2"	4 1/2	100	30	58,590
TUK-000500	5"	5	100	25	59,470

SOMUNLU KELEPÇE

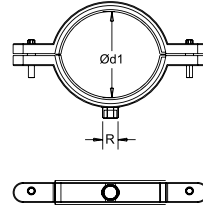

TRİFONLU STANDART KELEPÇE

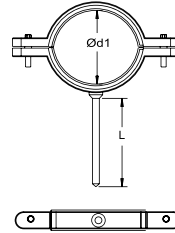

TRİFONLU UZUN KELEPÇE

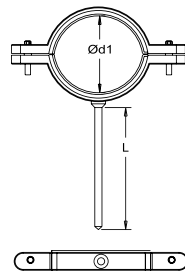

BORU MAKASI



Kod		Fiyat ₺
DBM-001242	GM 0012-42	515,640
DBM-002863	GM 0028-63	2.469,140
DBM-002775	GM 0027-75	3.086,420

KAYNAK MAKİNESİ SETİ



Kod		Fiyat ₺
KMS-000500	Cobra Kaynak Makinesi Set	2.880,660
KMS-0008A0	Ekonomik Kaynak Makinesi Set	2.304,530
KMS-002100	Yuvarlak Kaynak Makinesi Set	3.626,540

KAYNAK MAKİNESİ



Kod		Fiyat ₺
LKM-0009A0	Cobra Kaynak Makinesi	2.044,750
SKM-000900	Ekonomik Kaynak Makinesi	2.044,750
PKM-0009B0	Yuvarlak Kaynak Makinesi	2.662,040

TEST POMPASI

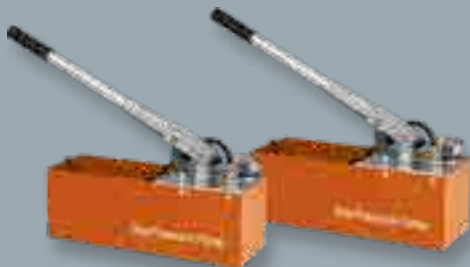

Kod		Fiyat ₺
TSP-003000	GM 0030	6.018,520

Kod	Ölçü (ø)	Fiyat ₺
BTA-202500	20 x 25	540,120
BTA-324000	32 x 40	648,150
BTA-506300	50 x 63	887,350

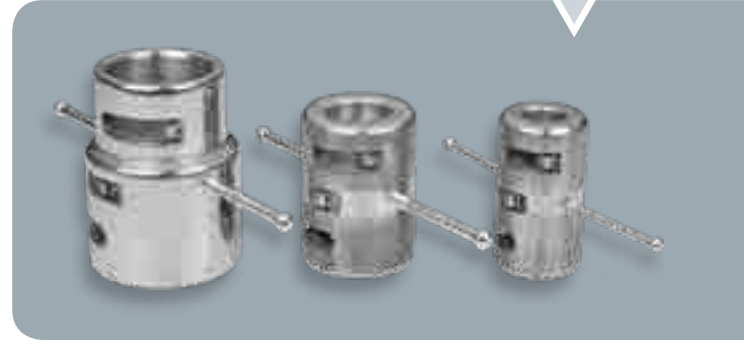
BORU TRAŞLAMA

Kod	Ölçü (ø)	Fiyat ₺
BKP-200000	20	169,750
BKP-250000	25	195,220
BKP-320000	32	208,330
BKP-400000	40	270,060
BKP-500000	50	462,960
BKP-630000	63	536,270
BKP-750000	75	642,750
BKP-900000	90	1.068,670
BKP-110000	110	1.415,900
BKP-125000	125	1.682,100

KAYNAK PAFTASI

Kod	Ölçü (ø)	Fiyat ₺
BKP-632000	63/20	694,440
BKP-632500	63/25	694,440
BKP-633200	63/32	694,440
BKP-752000	75/20	733,020
BKP-752500	75/25	733,020
BKP-753200	75/32	733,020
BKP-902000	90/20	810,190
BKP-902500	90/25	810,190
BKP-903200	90/32	810,190
BKP-110200	110/20	848,770
BKP-110250	110/25	848,770
BKP-110320	110/32	848,770

BRANŞMAN KAYNAK PAFTASI

Kod	Fiyat ₺
BKA-000000	447,530

TAMİR APARATI



Birinci Kalite

formül[®]



TEKNİK BİLGİ

5

Polypropylene Random Copolimer (PP-R)

Ham maddenin en önemli özelliği, ısıya ve kimyasal etkilere karşı gösterdiği yüksek dirençtir. Bu direnç sayesinde PP-R ham maddesinden markamız altında üretilen Boru ve Ek Parçaları, soğuk ve sıcak su tesisatlarında başarıyla kullanılmaktadır. PP-R ham maddesinin monomer yapısına sahip olması sayesinde, bünyesinde hiçbir biyolojik maddenin barınmasına izin vermez. PP-R ham maddesinden üretilmiş PP-R Boru ve Ek Parçalara renk, tat ve koku vermeyen üstün özellikler sağlar. PP-R ham maddesi içme suyu tesisatlarında, sıcak su, radyatör ve yerden ısıtma sistemlerinde ve birçok endüstriyel dağıtım sistemlerinde uzun ömürlü olarak kullanılır.

PP-R ham maddesi diğer plastıklere göre birçok avantaja sahiptir örneğin; uzun ömürlüdür, basınç ve sıcaklığa karşı yüksek dayanım gösterir, daha esnektir, yüksek ses ve ısı yalıtımına sahiptir, yüksek yoğunluktadır ve erime akış hızı düşüktür. PP-R ham maddesi ASTM F 2389, DIN 8077, DIN 8078, EN ISO 15874 Standartlarının gereksinimlerini karşılar.

PP-R Boru Avantajları

- 20°C'de 50 yıla kadar dayanım sağlayabilir.
- +95°C sıcaklığa kadar dayanır.
- Birçok kimyasal maddeye karşı yüksek dayanım gösterir.
- Aşınma ve korozyon direnci yüksektir, kireçlenme ya da paslanma yapmaz.
- Suyun rengini, kokusunu ve tadını değiştirmez.
- İç yüzeyi pürüzsüz ve kaygandır, bu sebeple sürtünme, aşınma direnci yüksektir.
- Kullanımda sırasında montaj edilmesi kolaydır.
- Montaj esnasında iş ve malzeme kaybına sebep olmaz.
- PP-R ham maddesinin üstün özellikleri sayesinde yüksek ses ve ısı yalıtımı sağlar.
- Zor alev alır.
- Geri dönüştürülebilir, çevre dostudur.

Teknik Özellikler

Özellikler		Birim	Test Metodu	Değerler
Yoğunluk	+23°C	g/cm ³	ISO 1183	0,909
Erime Akış İndeksi	190 °C /5 kg	g/10 dk	ISO 1133	0,4-0,6
	230°C /2,16 kg	g/10 dk	ISO 1133	0,2-0,5
	230°C /5 kg	g/10 dk	ISO 1133	0,8-1,3
Çekme Mukavemeti (23°C)	(50 mm/dk)	MPa	ISO 527	25
Çekmedeki Uzama	(50 mm/dk)	%	ISO 527	10
Elastiklik Modülü	+23°C	N/mm ²	ISO 527	800
Charpy Darbe Dayanımı (Çentikli)	+23°C	kJ/m ²	ISO 179	>15
	0°C	kJ/m ²	ISO 179	>5
Charpy Darbe Dayanımı (Çentiksiz)	0°C	kJ/m ²	ISO 179	Hasar Yok
Vicat Yumuşama Noktası	(1 kg)	°C	ASTM D 1525 ISO 306 DIN 53460	130
	(5 kg)	°C		60
Doğrusal Isıl Genleşme Katsayısı		1/K	DIN 53752	1,5x10 ⁻⁴
Isıl İletkenlik		W/mK	DIN 52612	0,24
Sertlik (Shore)	(3 sn değer)		ISO 868	65
Boru Sürtünme Katsayısı				0,007

PP-R'den Yapılan Ek Parçaların Mekanik Özellikleri (TS EN ISO 15874-3)

Özellikler	Gereklilik	PP-R İçin Yapılan Test Parametreleri					Test Metodu
İç basınca karşı gösterilen direnç	Test süresi boyunca hasar olmamalı	Hidrostatik Basınç (Mpa)	Test Sıcaklığı (C°)	Test Periyodu (h)	Test edilecek ürün adedi	Test basıncı (Bar)	ISO 1167-1 ISO 1167-3
		16,0	20	1	3	53,1	
		3,5	95	1000	3	11,6	

Boruların Mekanik Özellikleri (TS EN ISO 15874-2)

Özellikler	Gereklilik	PP-R İçin Yapılan Test Parametreleri					Test Metodu
İç basınca karşı gösterilen direnç	Test süresi boyunca hasar olmamalı	Hidrostatik basınç (Mpa)	Test sıcaklığı (C°)	Test Periyodu (h)	Test edilecek ürün adedi	Test Basıncı (Bar)	ISO 1167-1 ISO 1167-2
		16,0	20	1	3	64	
		4,3	95	22	3	17,2	
		3,8	95	165	3	15,2	
		3,5	95	1000	3	14	

Boruların Fiziksel ve Kimyasal Özellikleri (TS EN ISO 15874-2)

Özellikler	Gereklilik	Test parametreleri		Test Metodu
		Parametre	Değer	
Boyutsal kararlılık	≤ %2	Test sıcaklığı PP-R İlgili maruz kalma süresi: en ≤ 8 mm 8mm ≤ en ≤ 16mm en > 16mm Numune sayısı	135 °C 1 h 2 h 4 h 3	Method B of ISO 2505 (oven test)
Hidrostatik basınca karşı gösterilen termal kararlılık	Test süresi boyunca hasar olmamalı	Test sıcaklığı Hidrostatik basınç Test süresi Numune sayısı	110 °C 1,9 MPa 8760 h 1	ISO 1167-1 ISO 1167-2
Darbe dayanımı	≤ %10	Test sıcaklığı Numune sayısı	0 °C 10	ISO 9854-1 ISO 9854-2
Erime akış hızı (ham madde)	≤ 0,5g /10 dk	Test sıcaklığı Kütle Numune sayısı	230 °C 2,16 kg 3	ISO 1133-1
Erime akış hızı (boru)	Aynı partideki hamur ile karıştırıldığında maksimum %30 fark olmalı	Test sıcaklığı Kütle Numune sayısı	230 °C 2,16 kg 3	

Boru çapları ve toleranslar DIN 8077 standardına göre tablanmıştır.

SDR 11 (PN10)

Dış çap Ø mm.	Tolerans mm.	Et kalınlığı mm.	Tolerans mm.	İç çap Ø mm.	In" inches
20	+0.3/-0	1.9	+0.3/-0	16.20	1/2"
25	+0.3/-0	2.3	+0.4/-0	20.40	3/4"
32	+0.3/-0	2.9	+0.4/-0	26.20	1"
40	+0.4/-0	3.7	+0.5/-0	32.60	1 1/4"
50	+0.5/-0	4.6	+0.6/-0	40.80	1 1/2"
63	+0.6/-0	5.8	+0.7/-0	51.40	2"
75	+0.7/-0	6.8	+0.8/-0	61.40	2 1/2"
90	+0.9/-0	8.2	+1.0/-0	73.60	3"
110	+1.0/-0	10.0	+1.1/-0	90.00	4"
125	+1.2/-0	11.4	+1.3/-0	102.20	5"

SDR 7,4 (PN16)

Dış çap Ø mm.	Tolerans mm.	Et kalınlığı mm.	Tolerans mm.	İç çap Ø mm.	In" inches
20	+0.3/-0	2.8	+0.4/-0	14.00	1/2"
25	+0.3/-0	3.5	+0.5/-0	18.00	3/4"
32	+0.3/-0	4.4	+0.6/-0	23.20	1"
40	+0.4/-0	5.5	+0.7/-0	29.00	1 1/4"
50	+0.5/-0	6.9	+0.8/-0	36.20	1 1/2"
63	+0.6/-0	8.6	+1.0/-0	45.80	2"
75	+0.7/-0	10.3	+1.2/-0	54.40	2 1/2"
90	+0.9/-0	12.3	+1.4/-0	65.40	3"
110	+1.0/-0	15.1	+1.7/-0	79.80	4"
125	+1.2/-0	17.1	+1.9/-0	90.80	5"

SDR 6 (PN20)

Dış çap Ø mm.	Tolerans mm.	Et kalınlığı mm.	Tolerans mm.	İç çap Ø mm.	In" inches
20	+0.3/-0	3.4	+0.5/-0	13.20	1/2"
25	+0.3/-0	4.2	+0.6/-0	16.60	3/4"
32	+0.3/-0	5.4	+0.7/-0	21.20	1"
40	+0.4/-0	6.7	+0.8/-0	26.60	1 1/4"
50	+0.5/-0	8.3	+1.0/-0	33.40	1 1/2"
63	+0.6/-0	10.5	+1.2/-0	42.00	2"
75	+0.7/-0	12.5	+1.4/-0	50.00	2 1/2"
90	+0.9/-0	15.0	+1.7/-0	60.00	3"
110	+1.0/-0	18.3	+2.0/-0	73.40	4"
125	+1.2/-0	20.8	+2.2/-0	83.40	5"

Kullanım ömürleri DIN 8077 standardına göre belirlenmiştir. (SF=1,5)

Kullanım sıcaklığı (C°)	Kullanım ömrü	PN10	PN16	PN20
		Boru serisi (S)		
		5	3,2	2,5
		SDR		
		11	7,4	6
İzin verilen çalışma basıncı (Bar)				
10	1	17,5	27,8	35,1
	5	16,5	26,2	33,0
	10	16,1	25,6	32,2
	25	15,6	24,7	31,1
	50	15,2	24,1	30,3
20	1	15,0	23,7	29,9
	5	14,1	22,3	28,1
	10	13,7	21,7	27,4
	25	13,2	21,0	26,4
	50	12,9	20,4	25,7
30	1	12,7	20,2	25,4
	5	11,9	18,9	23,8
	10	11,6	18,4	23,2
	25	11,2	17,7	22,3
	50	10,9	17,2	21,7
40	1	10,8	17,1	21,6
	5	10,1	16,0	20,2
	10	9,8	15,5	19,6
	25	9,4	15,0	18,8
	50	9,2	14,5	18,3
50	1	9,1	14,5	18,2
	5	8,5	13,5	17,0
	10	8,2	13,1	16,5
	25	7,9	12,6	15,9
	50	7,7	12,2	15,4
60	1	7,7	12,2	15,4
	5	7,1	11,3	14,3
	10	6,9	11,0	13,9
	25	6,6	10,5	13,3
	50	6,4	10,2	12,9
70	1	6,5	10,3	12,9
	5	6,0	9,5	12,0
	10	5,8	9,2	11,6
	25	5,0	8,0	10,0
	50	4,2	6,7	8,5
80	1	5,4	8,6	10,8
	5	4,8	7,6	9,6
	10	4,0	6,4	8,1
	25	3,2	5,1	6,5
95	1	3,8	6,1	7,6
	5	2,6	4,1	5,2

PP-R Borularda Termal Genleşme

PP-R borular, metal borulardan çok daha yüksek bir genleşme katsayısına sahiptir. Bu nedenle, kurulum sırasında bu özellik dikkate alınmalıdır.

Termal genleşmenin hesaplanması aşağıdaki gibidir:

$$\Delta L = L * \Delta T * \alpha$$

ΔT = Ortam sıcaklığı ile su sıcaklığı arasındaki fark Kelvin derece (K) veya Santigrat (°C) cinsinden.

ΔL = Uzunluk değişimi (mm)

L = Borunun başlangıç uzunluğu (m)

α = Doğrusal termal genleşme katsayısı. PP-R boruları için α değeri $1,5 * 10^{-4}$ (K-1)'dir.

Standart PP-R Borunun Termal Genleşmesi

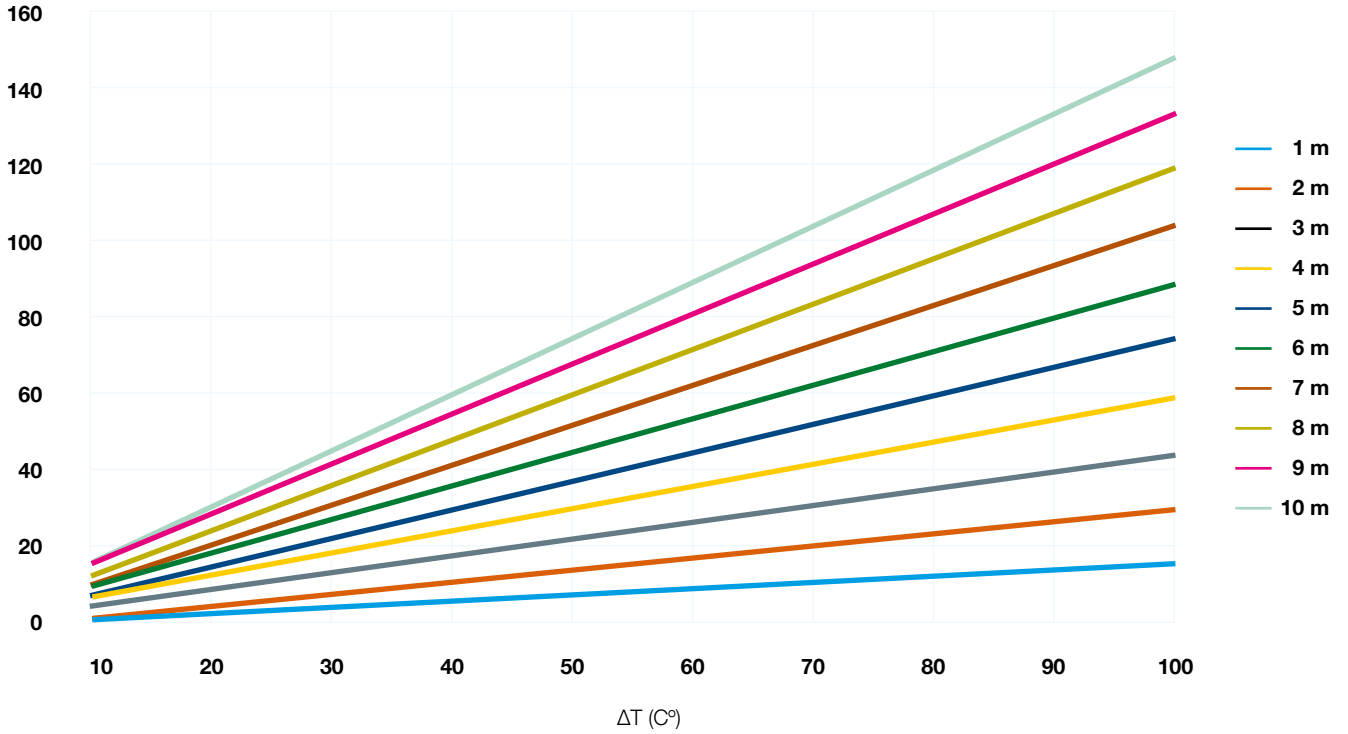

PP-R Cam Elyaf Takviyeli Boru

PP-R Cam Elyaf Takviyeli Boru (PP-R / GF / PP-R), iç ve dış katmanları PP-R'den ve orta katmanın özel PP-R ve cam elyaf karışımından oluşan 3 katman şeklinde üretilir.

PP-R Cam Elyaf Takviyeli Borunun Avantajları

1. Kaynak işleminden önce soyulmayı gerektirmediği için daha kolay ve daha hızlı kurulum sağlar.
2. Standart PP-R borudan% 75 daha az doğrusal genişleme özelliğine sahiptir.
3. Standart PP-R borudan daha yüksek sertliğe sahiptir.
4. Cam Elyaf PP-R borular, folyo borulara yakın termal genişleme katsayısına sahiptir, folyo boruların kullanıldığı alanlarda rahatlıkla kullanılabilir.

Genleşme katsayıları:

Cam Elyaf Takviyeli PP-R boru için: 0,035 mm / mK
Alüminyum Folyo Takviyeli PP-R Boru için: 0,030 mm / mK
Standart PP-R Boru için: 0,15 mm / mK

5. Standart PP-R borulardan daha hafiftir.

Kullanım Alanları

1. Her türlü sıcak ve soğuk su tesisatı
2. Pnömatik tesisatlar
3. Isıtma tesisatları ve radyatör bağlantıları.
4. Endüstriyel, sanayi sistemleri.

Cam Elyaf Takviyeli PP-R Boruda Termal Genleşme

Termal genişlemenin hesaplanması aşağıdaki gibidir:

$$\Delta L = L * \Delta T * \beta$$

ΔT = Ortam sıcaklığı ile su sıcaklığı arasındaki fark Kelvin derece (K) veya Santigrat (°C) cinsinden.

ΔL = Uzunluk değişimi (mm)

L = Borunun başlangıç uzunluğu (m)

β = Doğrusal termal genişleme katsayısı. Cam elyaf takviyeli PP-R boruları için β değeri $0,35 * 10^{-4}$ (K-1)'dir.

Cam Elyaf Takviyeli PP-R Boruda Termal Genleşme

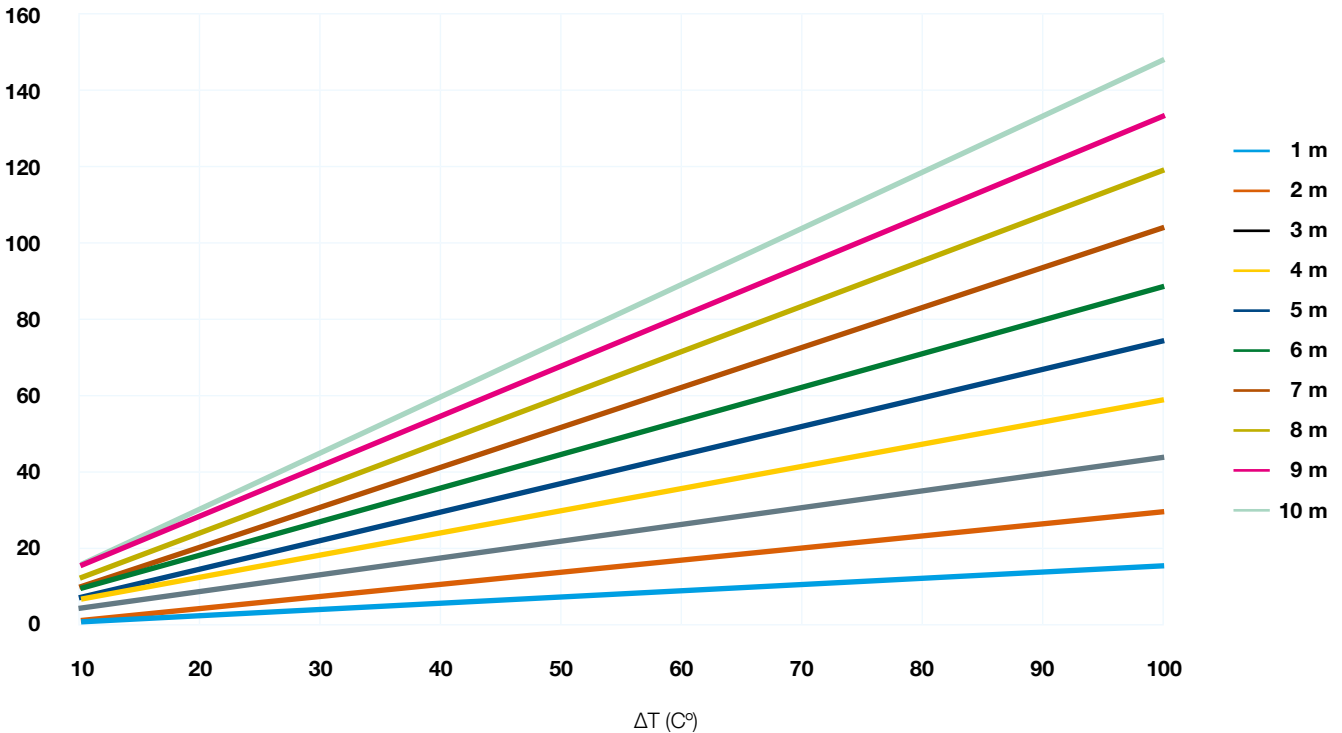

PP-R Alüminyum Folyo Takviyeli Boru

Bu borular üç katmandan oluşur: boru ve kaplama, aralarında alüminyum folyo bulunan PP-R'den yapılmıştır. Alüminyum folyo, sargı kaynağı ile ve alüminyum folyo ile PP-R tabakası arasındaki mekanik bağlantıyı kurmak için özel bir PP kaplama filmi kullanılarak yapıştırılır.

Özellikler

- Düşük termal genişleme
- Oksijen bariyer
- Düşük ısı kaybı
- Basınç ve sıcaklığa karşı yüksek direnç
- Kolay kurulum, şekillendirme ve uygulama
- Hijyenik
- Kimyasallara karşı dirençli
- Pürüzsüz olması sebebiyle düşük basınç kaybı

Oksijen Bariyer

Oksijen penetrasyonu, radyatör ve ısıtıcı cihazını aşındırarak çalışma ömrünü kısaltır. Atmosferik havadan oksijen difüzyonu, sisteme oksijen girişinin en yaygın yollarından biridir. Plastik borular bu penetrasyonu engellemez. Alüminyum tabaka, oksijen geçirmezliği sağlayarak radyatörün ve ısıtıcı cihazın ömrünü arttırır.

Alüminyum Folyo Takviyeli PP-R Boruda Termal Genleşme

Termal genişlemenin hesaplanması aşağıdaki gibidir:

$$\Delta L = L * \Delta T * \Phi$$

ΔT = Ortam sıcaklığı ile su sıcaklığı arasındaki fark Kelvin derece (K) veya Santigrat (°C) cinsinden.

ΔL = Uzunluk değişimi (mm)

L = Borunun başlangıç uzunluğu (m)

Φ = Doğrusal termal genişleme katsayısı. Alüminyum folyo takviyeli PP-R boruları için Φ değeri $0,30 * 10^{-4}$ (K-1)'dir.

Alüminyum Folyo Takviyeli PP-R Boruda Termal Genleşme

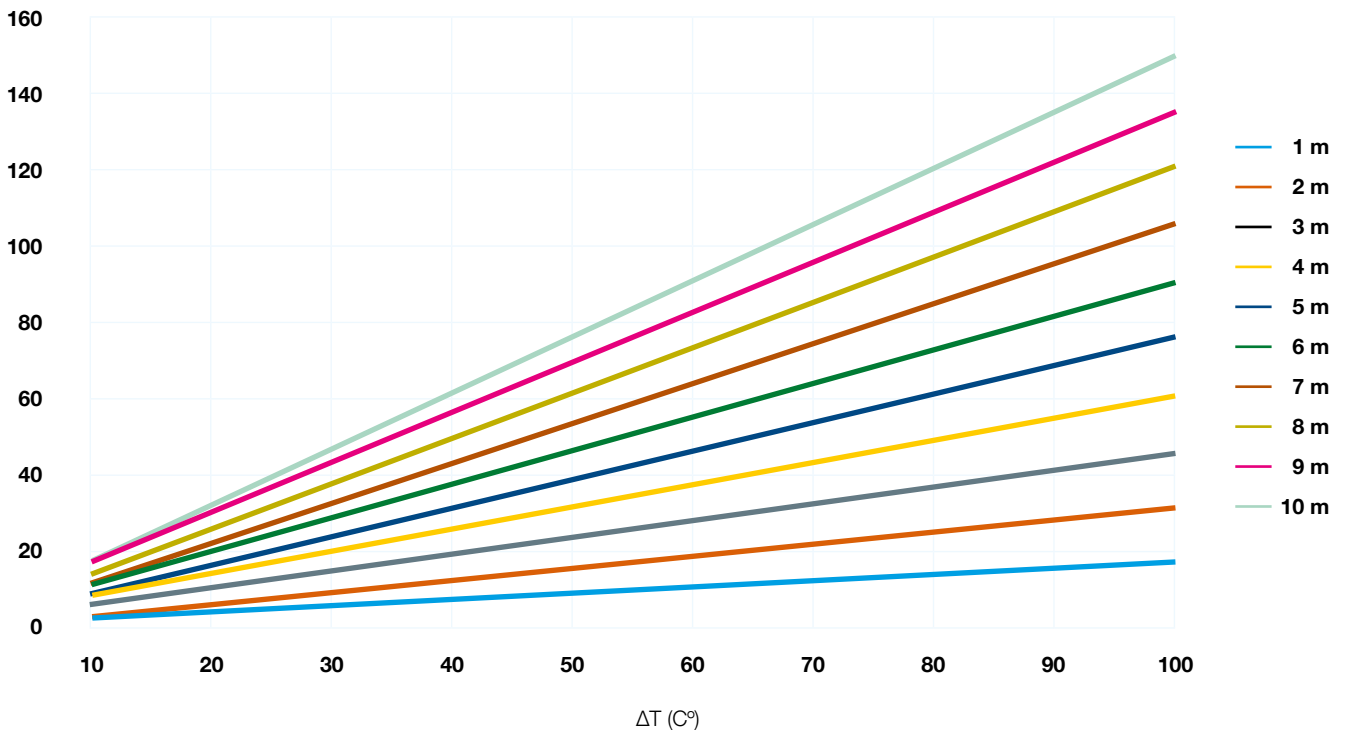

Standart Boru, Cam Elyaf Boru ve Alüminyum Folyo Takviyeli PP-R Boru Arasında Genişleme Karşılaştırması

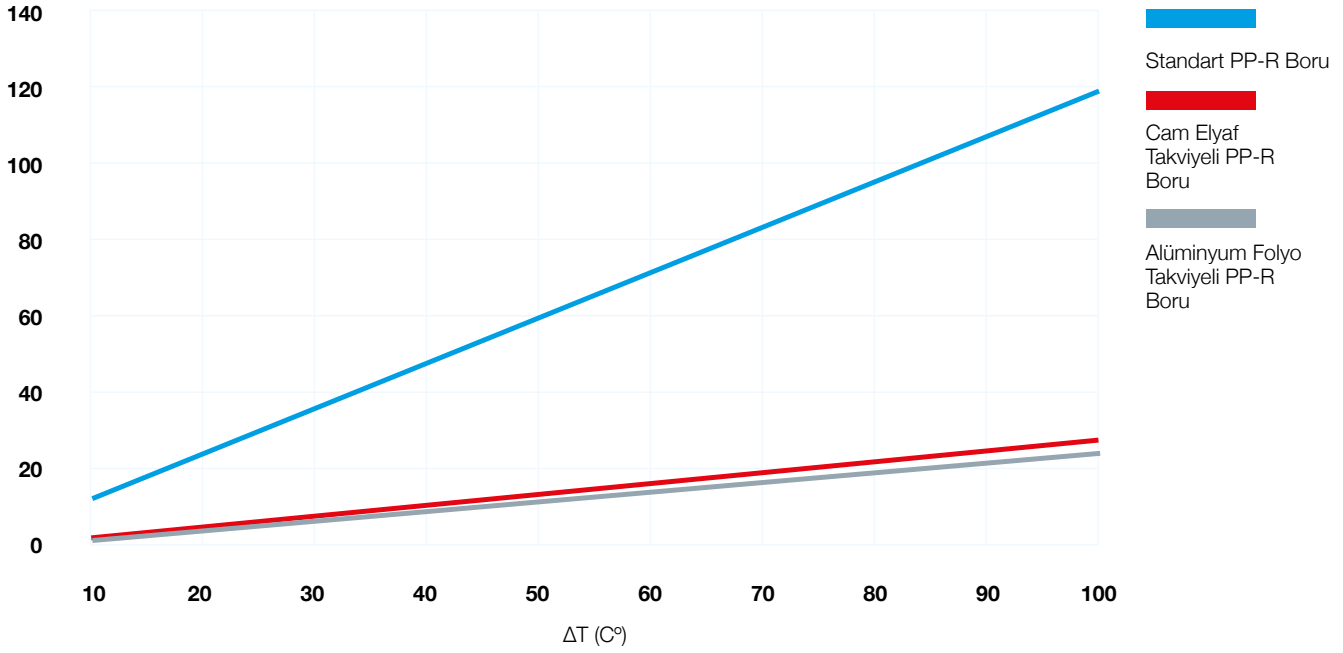

Kaynak Tekniği

PP-R borular ve bağlantı parçaları soket kaynağı ile birleştirilirler. Bu işlem kaynak makinesi kullanılarak yapılır. Tesisatın kullanım ömrü ve kalitesi, doğru ve tekniğine uygun yapılan kaynak ve bağlantılar ile doğrudan ilişkilidir. Boru ve bağlantı parçalarını birbirine kaynaklamak sadece birkaç saniye süren bir işlemdir. **Doğru kaynak tekniğini sıralamak gerekirse aşağıdakiler gibi sıralanabilir;**

- Kaynak yapılacak boru ve ek parçaların kaynak yüzeyleri temizlenir.
- Kaynak yapılacak boru ve bağlantı parçaları boyutuna uygun teflon kaplanmış uygun paftalar kaynak makinesinin üzerinde hazırlanır.
- Kaynak makinesi kaynak yapılmadan önce 270°C ±10 gelecek şekilde ısıtılır.
- Kaynak yapılacak boru, boru eksenine dik olarak düzgün bir biçimde kesilir.
- Boru kaynak mesafesi boru üzerinde işaretlenir. (Kaynak derinlikleri aşağıdaki tabloda belirtilmiştir.)
- Boru, boru paftasına bağlantı parçası, bağlantı parçası paftasına karşılıklı olarak yavaşça ısıtılarak işaretli kaynak derinliği noktasına kadar yerleştirilir.
- Kaynak makinesindeki paftalarda birkaç saniye ısıtılan boru ve bağlantı parçaları paftalardan çıkarılır ve birleştirilerek kaynak edilir.
- Kaynağın tamamlanarak, daha sağlıklı olması açısından herhangi bir işlem yapmadan önce kaynak soğuyana dek beklenmelidir.



Dış Çap (mm)	Isıtma Süresi (sn)	Birleştirme Süresi (sn)	Soğutma Süresi (dk)	Kaynak Derinliği (mm)
20	5	4	2	14,5
25	7	4	3	16
32	8	6	4	18
40	12	6	4	20,5
50	18	6	5	23,5
63	24	8	6	27,5
75	30	8	8	31
90	40	8	8	35,5
110	50	10	8	41,5
125	60	10	8	46,5

Montaj Sonrası Test Prosedürü

Test prosedürünü başlatmak için montajdan sonra sistem kontrol edilmelidir, lütfen aşağıdaki adımları takip edin.

-Sistemdeki tüm vanalar kapatılmalıdır.

-Sistemi doldururken, ilk ana vana hafifçe açılır.

-Güçlü basınç etkilerinden kaçınmak için, boru hattının en yüksek ve en uzak bölümlerdeki kullanım noktalarından hava basıncı düşürmelidir.

-Her bölgenin vanalarının açılmasıyla ayrı testler yapılır.

Kurulumun montajını bitirirken, aşağıdaki test prosedürü izlenerek sistemin kalite kontrolü yapılmalıdır. Basınç testi iki aşamada yapılmalıdır.

1. İlk aşama için; test basıncı izin verilen çalışma basıncı artı 5 bar basınca eşit olmalı ve 30 dakika içersin de 10'ar dakikalık aralıklarla iki kez tekrarlanmalıdır. Daha sonra 30 dakika sonrasında basıncın 0,6 bar 'dan daha fazla düşüp düşmediği ve sızıntı olup olmadığı kontrol edilmelidir.

2. İkinci aşama, birinci aşamayı aralıksız takip etmeli ve çalışma basıncı artı 5 bar basınç 2 saat boyunca verilmeli ve daha sonra basıncın 0,2 bar'dan fazla düşüp düşmediği ve boru tesisatında herhangi bir sızıntı belirtisi olup olmadığı kontrol edilmelidir.

Test sonrası herhangi bir yerde su sızması ve prosedürde belirtilen basınç değerinden fazla kayıp yoksa tesisat kapatılmalı ve uzun süre kullanılmayacaksa donmaya karşı boşaltılmalıdır. Eğer yukarıda verilen değerlere aykırı bir ölçüm söz konusu olursa sızdıran boru hattı kontrol edilmeli ve gerekli onarım yapıldıktan sonra test tekrarlanmalıdır.

Tesisattaki Genleşmelerin Telafisi

Borular zeminin altına veya üstüne monte edilebilir. Kurulum çok kolay ve hızlıdır. Bununla birlikte, polipropilen boruları monte ederken aşağıdaki basit noktalara dikkat etmek gerekir.

Omega ve U parçaları, sıcak hatlardaki borularda kullanılmak için tasarlanmıştır. Bu parçalar, düz borulardaki genleşmeleri telafi etmek için kullanılırlar. Omega ve U parçaları yerine metal kompensatörler de kullanılabilir.

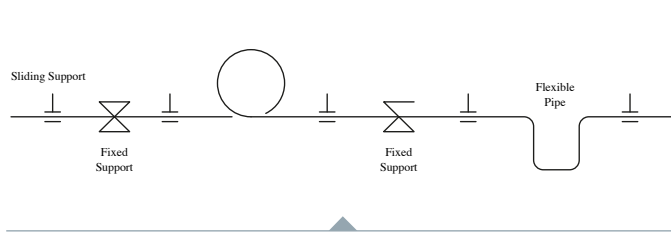

Şekil 1- Omega ve U kısmı

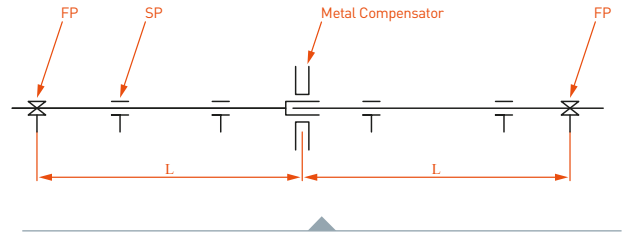

Şekil 2- Metal Dengeleyici

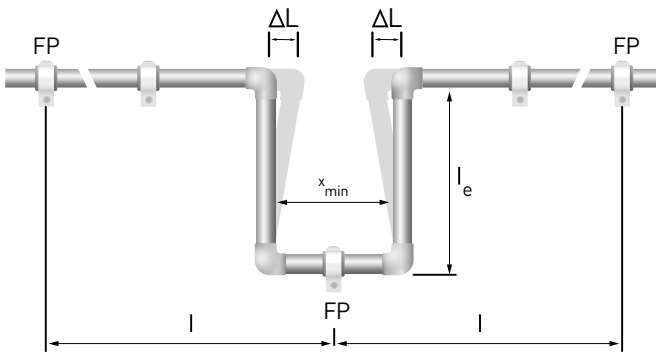

Şekil 3-Bükme kısmının mesafesi

Bükme kısmının uzunluğu aşağıdaki denklem ile hesaplanır:
 $Le = k * d * \Delta L$

Le = Bükme parçasının uzunluğu (U kısmı, mm)

d = Borunun dış çapı (mm)

ΔL = Uzunluk değişimi (mm)

k = Malzemeye bağlı sabit (PP için 15)

FP: Sabitleme noktası, destek noktası.

SP: kayar nokta, destek noktası.

KELEPÇE DESTEK MESAFELERİ

Standart PP-R Boruların Kelepçe Destek Mesafeleri (cm)

Sıcaklık Farkı ΔT (°C)	Standart PP-R Boru Çapı (mm)									
	20	25	32	40	50	63	75	90	110	125
0	85	105	125	140	165	190	205	220	250	270
20	60	75	90	100	120	140	150	160	180	195
30	60	75	90	100	120	140	150	160	180	195
40	60	70	80	90	110	130	140	150	170	185
50	60	70	80	90	110	130	140	150	170	185
60	55	65	75	85	100	115	125	140	160	175
70	50	60	75	80	95	105	115	125	140	150

Cam Elyaf Takviyeli PP-R Boruların Kelepçe Destek Mesafeleri (cm)

Sıcaklık Farkı ΔT (°C)	Cam Elyaf Takviyeli PP-R Boru Çapı (mm)									
	20	25	32	40	50	63	75	90	110	125
0	115	130	150	165	185	215	240	260	280	295
20	90	100	115	130	145	165	185	200	215	225
30	90	100	115	130	145	165	185	200	210	220
40	80	90	105	120	135	155	175	190	200	210
50	80	90	105	120	135	155	175	190	180	190
60	70	80	100	115	130	145	165	180	175	180
70	65	75	90	105	120	135	155	175	175	180

Alüminyum Folyo Takviyeli PP-R Boruların Kelepçe Destek Mesafeleri (cm)

Sıcaklık Farkı ΔT (°C)	Alüminyum Folyo Takviyeli PP-R Boru Çapı (mm)									
	20	25	32	40	50	63	75	90	110	125
0	155	170	195	220	245	270	285	300	325	345
20	120	130	150	170	190	210	220	230	250	265
30	120	130	150	170	190	210	220	230	240	250
40	110	120	140	160	180	200	210	220	210	220
50	110	120	140	160	180	200	210	220	210	220
60	100	110	130	150	170	190	200	210	200	210
70	90	100	120	140	160	180	190	200	200	200

KİMYASAL DİRENÇ

Polipropilen, çok yüksek kimyasal dirence sahip bir polimerdir. Kimyasal direnç, bileşim, kalite durumu, eğilim zamanı, konsantrasyon ve sıcaklık gibi faktörlere göre değişir. Aşağıda gösterilen tablolar farklı sıcaklık ve konsantrasyonlarda kimyasal direnç vermektedir.

S : Doymuş çözelti
f : Dayanıkl
p : Kısmen dayanıklı
n : Dayanıkl değil

Ürünler	Yoğunluk	Sıcaklık		
	%	20 C°	60 C°	100 C°
Akümülatör Asidi		f	f	
Asedik Buzul Asidi	100	f	p	n
Asetik Asit	50	f	f	
Asetik Asit	10	f	f	
Asetik Anhidrit	100	f		
Aseton	100	f	p	n
Akrilonitril	100	p		
Şap	All	f	f	
Amonyak	High	f	f	

Ürünler	Yoğunluk	Sıcaklık		
	%	20 C°	60 C°	100 C°
Amonyak	10	f	f	
Amonyak	100	f	f	
Amonyum Asetat	All	f	f	f
Amonyum Karbonat	All	f	f	
Amonyum Klorür	All	f	f	f
Amonyum Nitrat	All	f	f	f
Amonyum Metafosfat	S	p	p	p
Amonyum Fosfat	All	f	f	f
Amonyum Sülfat	S	p	p	p
Amonyum Bikarbonat	S	p	p	
Hayvansal Pişirme Yağı		f	p	
Araba Anti-Frizi		f	f	
Kral Suyu		f	n	
Barium Klorür	All	f	f	f
Bira		f		
Benzaldehit		f	f	
Benzaldehit	S	f	f	f
Benzen		p	n	
Benzoik Asit	S	f	f	p
Benzoil Klorür	100	n		
Acı Badem Yağı		f		
Çamaşır Suyu	12.50%	p	p	
Boraks				
Borik Asit	100	f	f	
Borik Asit	S	f	f	
Brendi		f		
Brom	100	n		
Brom	High	n	n	
Brom	Low	n	n	
Bütan	100	f		
Bütan (P)	100	f	f	
Tereyağı		f	f	
Bütil Alkol	100	f	f	
Kalsiyum Nitrat	S	f	f	
Kafur		f		
Karbon Tetra Klorür	100	p	n	
Klor	100	n		
Klor (Kuru)	100	n	n	n
Klor (Islak)	10	p	n	n
Klorasülfonik	100	n	n	

Ürünler	Yoğunluk	Sıcaklık		
	%	20 C°	60 C°	100 C°
Kromik Asit	S	f	n	
Chromium (3) Tuzları				
Chromium (6) Tuzları				
Sitrik Asit	S	f	f	f
Kakao		f	f	p
Morina Karaciğeri Yağı		f		
Cresol	100	f	p	
Cresol	S	f	p	
Kresol Yağı		f		
Sikloheksan	100	f		
Cycloexanol	100	f	p	
Cycloexanon	100	f	n	
Decahydronaphthlene	100	p	n	n
Dioksan	100	f	p	n
Artılmış Su	100	f	f	n
Motor Yağı		f	p	
Etil Alkol	100	f		
Etil Alkol	96	f	f	
Etil Alkol	50	f	f	
Eterler	100	f	p	
Etil Alkol (Denatüre)	10	f	f	
Etil Klorürler	100	n		
Etilen Klorürler	100	p	p	
Etilen Tetraklorür	100	p	n	
Formaldehit	40	f	f	
Formaldehit	30	f	f	
Formaldehit	10	f	f	
Formik Asit	98	f	p	
Formik Asit	90	f		
Formik Asit	50	f	f	
Formik Asit	10	f	f	f
Meyve Suyu		f	f	
Fumik Sülfürik Asit		n	n	n
Galvanik Çözeltiler		f	f	
Gliserin	100	f	f	
Gliserin	High	f	f	
Gliserin	Low	f	f	f
Glikol	100	f	f	
Glikol	High	f	f	
Glikol	Low	f	f	f

Ürünler	Yoğunluk	Sıcaklık		
	%	20 C°	60 C°	100 C°
Heptan	100	f	p	
Hekzan	100	f	p	
Bal		f	f	
Hidrobromik Asit	10	f	f	
Hidroflorik Asit	40	f	f	
Hidrojen Peroksit Su	30	f	p	
Hidrobromik Asit	High	f	f	
Hidrojen Peroksit Su	10	f	f	
Hidrojen Peroksit Su	3	f	f	f
Mürekkep		f	f	
Izo Oktan	100	f	p	
Laktik Asit	90	f	f	
Laktik Asit	50	f	f	
Laktik Asit	10	f	f	f
Likit Su	100	f	f	f
Kireç Taşı		f	f	f
Keten Tohumu Yağı		f	f	
Civa		f	f	
Civa Tuzları	100			
Metil Alkol	50	f	f	
Metil Alkol	100	f	f	
Metil Klorür	100	p		
Metil Etil Keton	100	f	p	
Metilen Formaldehit		f		
Süt		f	f	p
Mineralli Su		f	f	f
Neft		f	p	
Naftalin	100	f		
Nitro Benzen	100	p	p	
Normal Benzin		p	n	
Yağ		n	n	
Oleik Asit	100	f		
Zeytin Yağı		f	f	
Nitrik Asit	50	p	n	
Nitrik Asit	25	f	f	
Nitrik Asit	10	f	f	
Oksalik Asit	S	f	f	f
Ozon	<0.5 ppm	p	p	
Parafin	100	f	f	n
Petrol	100	f	p	

Ürünler	Yoğunluk	Sıcaklık		
	%	20 C°	60 C°	100 C°
Fenilamin		f	p	
Fenilamin Metil Keton	100	p	p	
Fosforik Asit	S	f	p	
Fosforik Asit	50	f	f	
Fosforik Asit	10	f	f	f
Potasyum Karbonat	S	f	f	
Potasyum Klorat	S	f	f	
Potasyum Klorür X	S	f	f	f
Potasyum Dikromat	S	f	f	f
Potasyum Hidroksit	50	f	f	
Potasyum Hidroksit	25	f	f	
Potasyum Hidroksit	10	f	f	
Potasyum Hipoklorit	5	f		
Potasyum İyodür	S	f	f	
Potasyum Nitrat	S	f	f	
Deniz Suyu		f	f	f
Şampuan		f	f	
Silikon Yağı		f	p	
Sabun Çözeltisi	S	f	f	
Sabun Çözeltisi	10	f	f	f
Sodyum Bikarbonat	S	f	f	f
Potasyum Sülfate	S	f	f	f
Propan ®	100	f	f	f
Propan	100	f	f	f
Piridin	100	f	p	
Sodyum Karbonat	S	f	f	
Sodyum Karbonat	10	f	f	f
Sodyum Klorat	5	f		
Sodyum Klorat	25	f	f	
Sodyum Klorit	S	f	f	f
Sodyum Disülfid	S	f	f	f
Sodyum Hidroksit	100	f	f	
Sodyum Hidroksit	50	f	f	
Sodyum Hidroksit	25	f	f	
Sodyum Hidroksit	10	f	f	
Sodyum Nitrat	S	f	f	
Sodyum Nitrit (P)	S	f		
Sodyum Perborat	S	f	f	f
Sodyum Fosfat	S	f	f	f

Ürünler	Yoğunluk	Sıcaklık		
	%	20 C°	60 C°	100 C°
Sodyum Sülfat	S	f	f	f
Sodyum Sülfid	S	f	f	
Çözünebilir Kahve		f	f	f
Soya Fasulyesi Yağı		f	p	
Sülfokromik Asit		n	n	
Sülfür	100	f	f	f
Sülfürik Asit	96	f	p	
Sülfürik Asit	50	f	f	
Sülfürik Asit	25	f	f	
Sülfürik Asit	10	f	f	f
Kükürt Anhidrit	Low	f	f	
Spirits		f		
Kalay Klorür	S	f	f	
Nişasta	All	f	f	
Sitrik Asit	100	f		
Süksinik Asit	100	f	f	
Süper Benzin		p	n	
Sentetik Temizleyici		f	f	f
Katran		f	p	
Tartarik Asit	S	f	f	
Tartarik Asit	10	p	p	
Tetrahidrofuran	100	p	n	
Tetrahidro Naftalin	100	p	n	
Thea		f	f	p
Tiyofen	100	p	n	
Tolüen	100	p	n	
Domates Suyu		f	f	
Diş Macunu		f	f	
Trichloroethylene	100	p	p	
Türpentin		n	n	n
Türpentin Yağı		p	n	
İki Zamanlı Motor Yağı		p	p	
Daktilo Yağı		f	p	
Üre	S	f	f	
Vazelin		f	p	
Bitkisel Pişirme Yağı		f	p	
Su	100	f	f	f
Krema		f		
Viski	40	f		
Ksilen	100	p	n	

Ek Parçaların Metal İnsertlerinin Ham maddesi Olan Pirinç MS58 İçeriği

Bakır

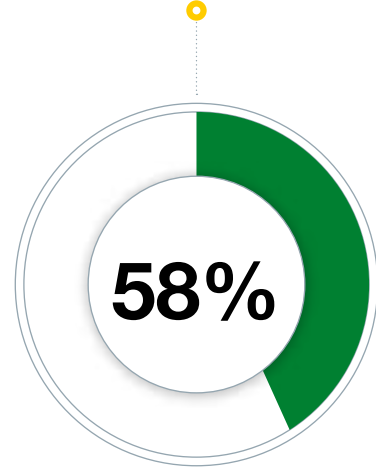

Çinko

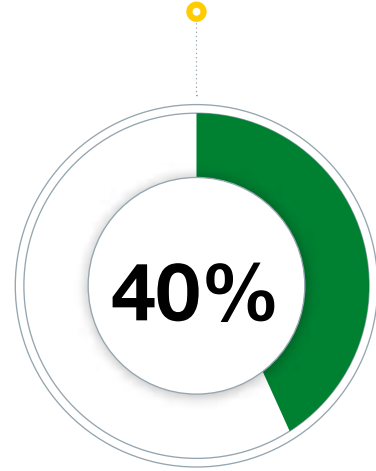

Diğerleri

Pb, Sn, P, Mn, Fe, Ni, Si, Mg, Cr, Al, etc.

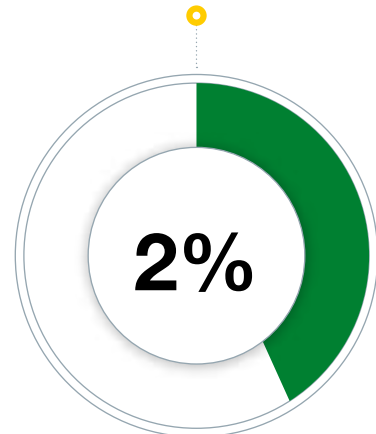

Kullanılan Normlar

TS-DIN 1988

İçme suyu hat montajı.

TS-DIN 2999

Boru ve Ek Parçaları için Whitworth boru dişleri.

TS-DIN 4109

Bina yapımında ses yalıtımı.

TS-DIN 8077

Polypropylene (PP-R) boru boyutları.

TS-DIN 8078

Polypropylene (PP-R) boru genel kalite gereklilikleri ve testleri.

TS-DIN 16928

Boru bağlantıları ve bileşenleri - Termoplastik malzeme boruları; boru bağlantıları, boru elemanları, döşeme; genel talimatlar.

TS-DIN 16962 (6-9)

Polipropilen (PP-R) basınçlı boru hatları için boru bağlantıları ve elemanları, tip 1 ve 2; soket kaynağı için enjeksiyon kalıplı dirsekler, boyut.

TS-DIN 16962.5

Boru bağlantıları ve polipropilen bileşenleri (PP-R) Basınç altındaki borular için, Bölüm 5: Genel kalite gereklilikleri, test.

TS-DVS 2207.11

Plastik borular için kaynak düzenlemeleri.

TS-DVS 2208.1

Termoplastik boruların kaynağı için makine ve cihazlar.

TS-EN ISO 15874 -2-3

Sıcak ve soğuk su tesisatı için plastik boru sistemleri polipropilen (PP-R).

TSE K 28

Çok katmanlı cam Elyaf borular Polipropilen (PP-R) - sıcak ve soğuk su sistemleri için kullanılan basınçlı borular.

TS 9937

Polipropilenden (PP-R) Plastik Borular - genel amaçlı.

Taşıma ve Depolama

- Boruyu ve bağlantı parçalarını güneşten ve yağmurdan korunarak saklayın. UV radyasyonuna uzun süre maruz bırakmayın.



- 0°C'nin altındaki sıcaklıklarda saklamayın. Etkiler borular üzerinde çatlaklar oluşturabilir.



- Sert ve keskin nesnelerin etkisini koruyun.



- Oldukça dayanıklı olmasına rağmen, lütfen yükleme ve boşaltma sırasında atmayın.



- Lütfen dikkatli hareket edin ve istifleyin.



PE-RT Boru nedir?

PE-RT boru (Polietilen - Raised Temperature Resistance) ısıya dayanıklı PE borunun kısaltılmış halidir. PE-RT borular tecrübeli ve uzman ekibimiz tarafından son teknoloji ile donatılmış makinelerde ISO 22391-2 standardına uygun olarak yüksek kalitede üretilmektedir.

PE-RT Boru Özellikleri

- PE-RT borular çevre ile dost geri dönüştürülebilir termoplastik malzemelerden olan Tip 2 PE-RT ham maddeden üretilmektedir.
- PE-RT borular esneklik özelliği sayesinde soğuk havalarda ısıtmaya gerek kalmadan kolayca döşenebilir.
- PE-RT borular özel olarak geliştirilen ham madde nedeniyle yüksek ısı ve basınca dayanıklı olup kimyasallara karşı yüksek dirence sahiptir.
- PE-RT borular içme suyunda kullanılabilir.
- Borular üretildikten sonra kangallar halinde ambalajlanır ve kolayca taşınır.
- Boruların dış çapı 16 mm, et kalınlığı ise 2 mm' dir.
- Kırmızı, Mavi iki renk kılıflı, standart ve oksijen bariyerli olarak çeşitleri mevcuttur.

Oksijen Bariyerli PE-RT Boru Özellikleri

Bariyerli PE-RT borular özel olarak geliştirilmiş EVOH katmanı sayesinde oksijen geçirmez. Bu sayede mevcut sistemde yer alan pompa, vana, radyatör gibi bağlantı elemanlarının korozyona uğramasının önüne geçilir. Böylelikle sistemde yer alan bağlantı elemanlarının servis ömrü uzar, bakım ve onarım maliyetleri en aza inmiş olur.

PE-RT Boru Kullanım Alanları

- PE-RT borular;
- Sıcak & soğuk temiz su tesisatları,
 - Merkezi ısıtma,
 - Yerden ısıtma,
 - Radyatör bağlantıları ve
 - Endüstriyel uygulamalarda kullanılmaktadır.

PE-RT Borunun Diğer Borulardan Farkı Nedir?

Piyasada bulunan diğer tip borular özellikle soğuk hava koşullarında esnekliğini kaybeder. Sistemin döşenebilmesi için ısıtma cihazlarına ihtiyaç duyulur. PE-RT borular ham madde yapısı gereği esnek yapıya sahiptirler ve böylelikle soğuk havalarda ısıtmaya ihtiyaç duymadan döşenebilir.

PE-RT Tip 2 ham maddesi sayesinde PE-RT borularda PE-X borularda var olan çapraz bağlanmaya ihtiyaç duyulmadan yüksek sıcaklıkta uzun süreli hidrostatik mukavemet sağlanır. PE-RT boruların yüksek sıcaklıkta uzun dönem hidrostatik dayanıklılık sağlaması için çapraz bağlanma gerektirmeyişi PE-RT malzemesinin eşsiz özelliğidir. Bu özellik sayesinde çevre dostu ve geri dönüşümlü boru özelliğini kazanmaktadır.

PE-X borularda olduğu gibi çapraz bağlanmayı sağlayan herhangi bir kimyasal madde içermediğinden içme suyunda da kullanımı uygundur. İnsan sağlığına zararı yoktur.

Yerden ısıtma ve radyatör sistemlerinde iki tip plastik boru kullanılmaktadır. Bunlardan biri PE-X (polietilen cross-linked , PE çapraz bağlı) diğeri de PE-RT (polietilen raised temperature resitance)'dir. PE-X ve PE-RT boruların her ikisi de polietilen ham maddesinden üretilmektedir. PE-X boruların PE-Xa, PE-Xb, PE-Xc olarak isimlendirilen alt türleri mevcuttur. PE-X borularda c'den a'ya doğru borunun ısıya ve basınca dayanımı artmaktadır. Buna karşılık borularda esneklik özellikleri azalmaktadır. Boruların uygulama esnasında esneklik kazanması için ısıtılarak döşenmesi gerekmektedir. Bu durum zaman ve işçilik kayıplarına neden olmaktadır. PE-RT borular ise yapısında yer alan özel olarak geliştirilmiş PE-RT Tip 2 ham maddesi sayesinde en yüksek esneklik özelliği kazanılırken aynı zamanda borunun yüksek ısı ve basınç dayanım özellikleri de korunmaktadır. Böylelikle PE-RT borular ısıtma gerektirmeden soğuk olarak da döşenebilmektedir. PE-RT borular doğru malzeme seçimi ve doğru montaj teknikleri ile döşendiğinde 50 yıl ömre sahiptirler.

PE-RT Boru Basınç Dayanım Tablosu

16x2 mm PE-RT Boru (SF=1,5)		
Sıcaklık °C	Yıl	Basınç (Bar)
20	1	18,6
	5	18,2
	10	18,1
	25	17,9
	50	17,8
30	1	16,9
	5	16,6
	10	16,5
	25	16,3
	50	16,1
40	1	15,3
	5	15,0
	10	14,8
	25	14,6
	50	14,5
50	1	13,6
	5	13,3
	10	13,2
	25	13,0
	50	12,9
60	1	12,0
	5	11,7
	10	11,5
	25	11,4
	50	11,2
70	1	10,3
	5	11,1
	10	9,9
	25	9,8
	50	9,6
80	1	8,8
	5	8,5
	10	8,4
	25	8,2
95	1	6,5
	5	6,3
	10	6,2

Çevre Politikamız

Firmamız, çevre yönetim sistemimizi sürekli iyileştirecek hedefler belirlemeyi, bu hedefleri yapacağı toplantılarda gözden geçirmeyi, çalışanlara sağlıklı, güvenli ve temiz bir iş ortamı sunmayı amaçlamaktadır.

Bu yüzden politikamız;

- İlgili çevre ve enerji mevzuatı gereklerini karşılamak ve hatta aşmak,
- Çevre ve enerji yönetim sistemlerini sürekli geliştirmek için çalışmak,
- Atıkları minimuma indirmek, kirliliği kaynağında önlemek, enerjiyi verimli kullanmak ve faaliyetlerimizin çevre üzerindeki olumsuz etkilerini azaltmak,
- Çevreyi korumak ve bu prensibi tüm çevremize, ülkeye ve dünyaya yaymak,
- Çevre ile ilgili acil durumlar için riskleri belirlemek ve bunları azaltmak,
- Çalışanlara ve bayilerimize, çevre bilinci ve enerjinin verimli kullanımı ile ilgili bilinçlendirme eğitimleri vererek onları geliştirmek,
- Çevreye olan etkilerimizin azaltılması ve enerjinin verimli kullanılması için gerekli insan kaynağı, teknoloji ve finansal kaynakları sağlamaktır.



Fabrikamızda üretim yaparken ortaya çıkan enerjiyi, ısıtma ve soğutma sistemlerinde kullanarak enerji tasarrufunda da üzerimize düşeni yapmaktayız.

formül[®]

formül[®]
PP-R, PVC BORU ve EK PARÇALARI

Dünya Çapında

30
YILLIK
KALİTE
HİKAYESİ

50
YIL
GARANTİ

formul.com.tr

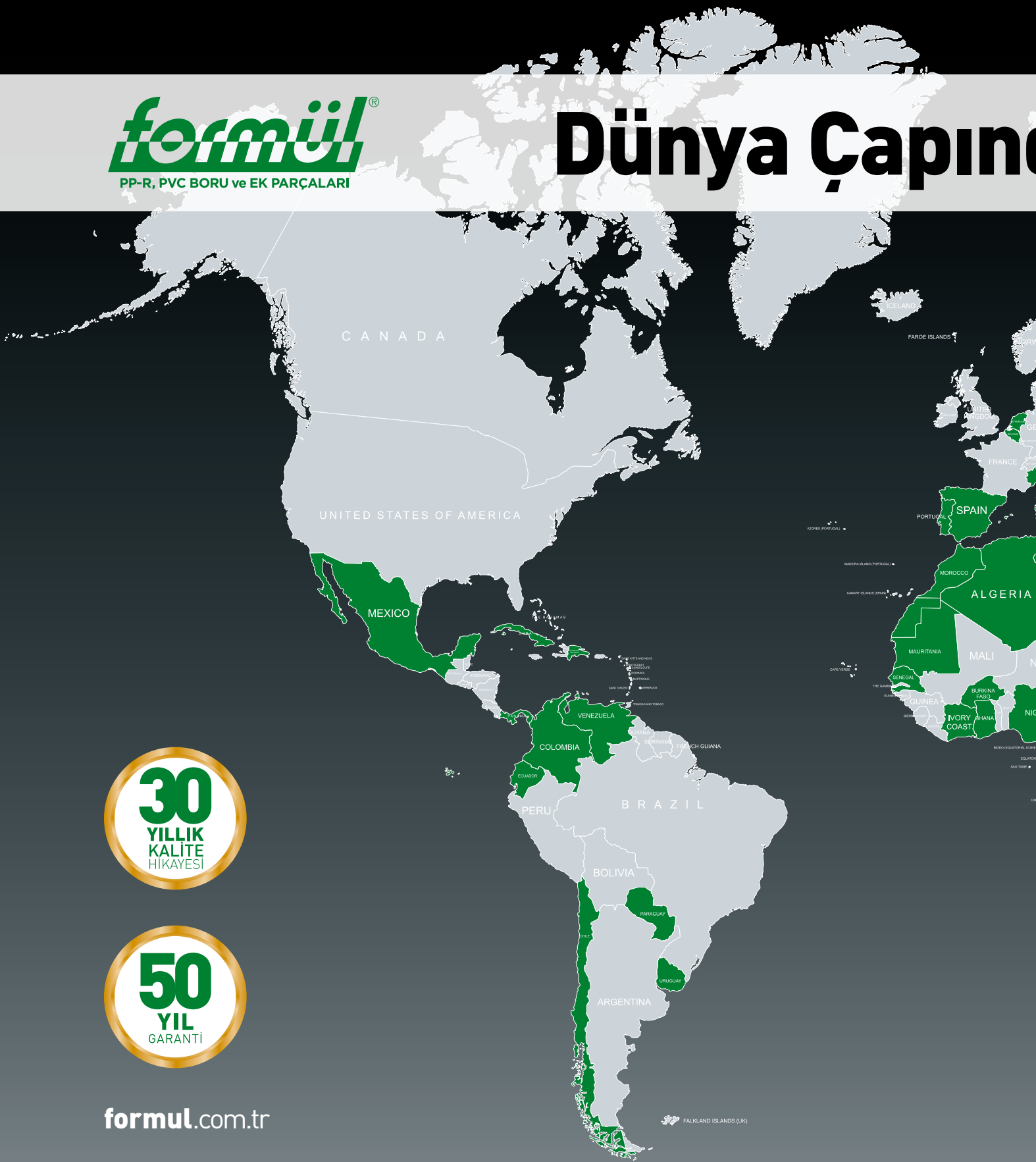

da Servis Ağı

5 kıtada 80'den fazla ülkede

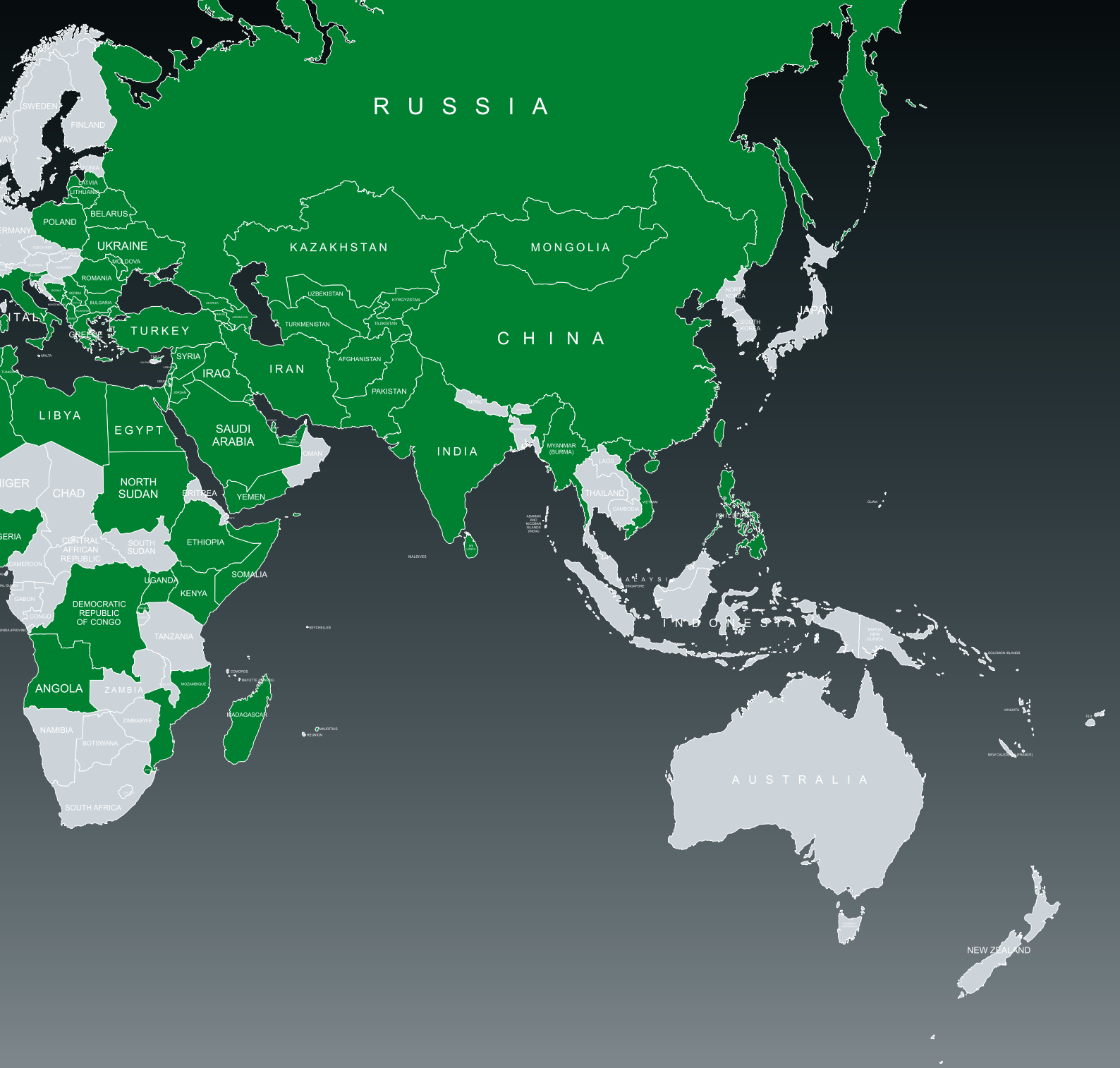



Dünya'nın Tercih, Türkiye'nin Markası

Bayi:



www.formul.com.tr
satis@formul.com.tr
satis-destek@formul.com.tr
satis-operasyon@formul.com.tr



MERKEZ OFİS

Cumhuriyet Mah. Gürpınar Yolu
Cad. Kaya Milenyum İş Merkezi
K:8 N:5A/144
Büyüçekmece / İSTANBUL

T: +90 212 876 12 60
F: +90 212 876 12 59



PLASTİK FABRİKASI

Veliköy OSB Sanayi Bulvarı
N:19/4A
Çerkezköy / TEKİRDAĞ

T: +90 282 746 15 60
F: +90 282 746 15 59



PVC FABRİKASI

Veliköy OSB Sanayi Bulvarı
2. Cad. N:19/1
Çerkezköy / TEKİRDAĞ

T: +90 282 746 15 54
F: +90 282 746 15 59



METAL FABRİKASI

Gazi Osmanpaşa OSB
1. Cad. N:135
Çerkezköy / TEKİRDAĞ

T: +90 282 758 25 06
F: +90 282 758 25 05

01.2022